

- 1 Aluminum profile Solar - Tech ST 67Z
- 2 Aluminum profile Solar - Tech ST 67ZG (GRIP)
- 3 Aluminum profile Solar - Tech ST L50Z
- 4 Load bearing bracket
- 5 Bracket for sliding connections
- 6 Steel post/pole
- 7 Dilatation 1 - 1,5 mm/m
- 8 Spacer
- 9 Welded bracket
- 10 Weld
- 11 Aluminum bracket

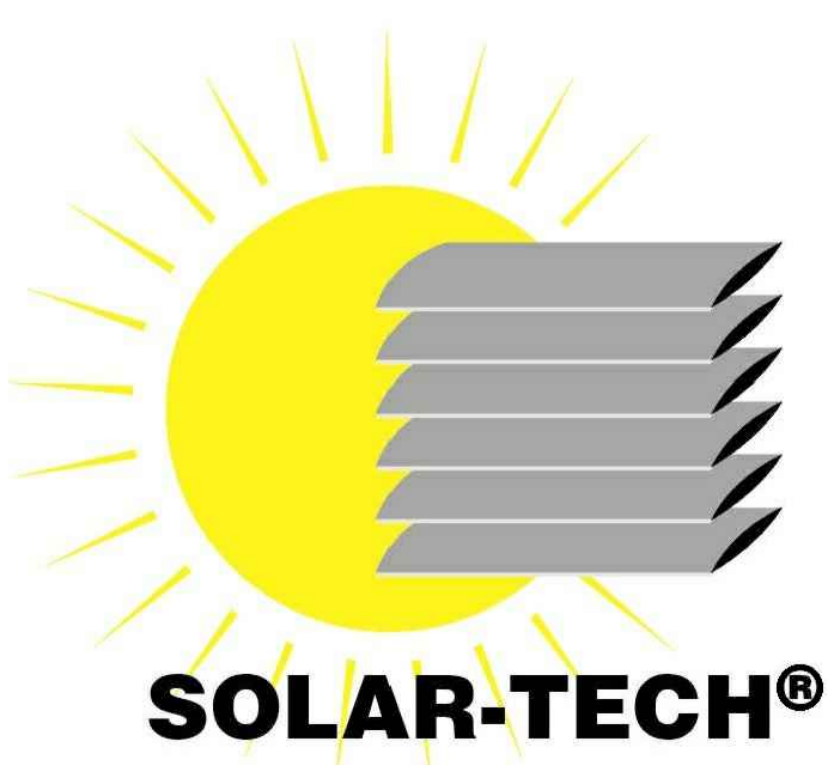

- 1 Aluminum profile Solar - Tech ST 67Z
- 2 Aluminum profile Solar - Tech ST 67ZG (GRIP)
- 3 Aluminum profile Solar - Tech ST L50Z
- 4 Load bearing bracket
- 5 Bracket for sliding connections
- 6 Steel post/pole
- 7 Dilatation 1 - 1,5 mm/m
- 8 Spacer
- 9 Welded bracket
- 10 Weld
- 11 Aluminum bracket

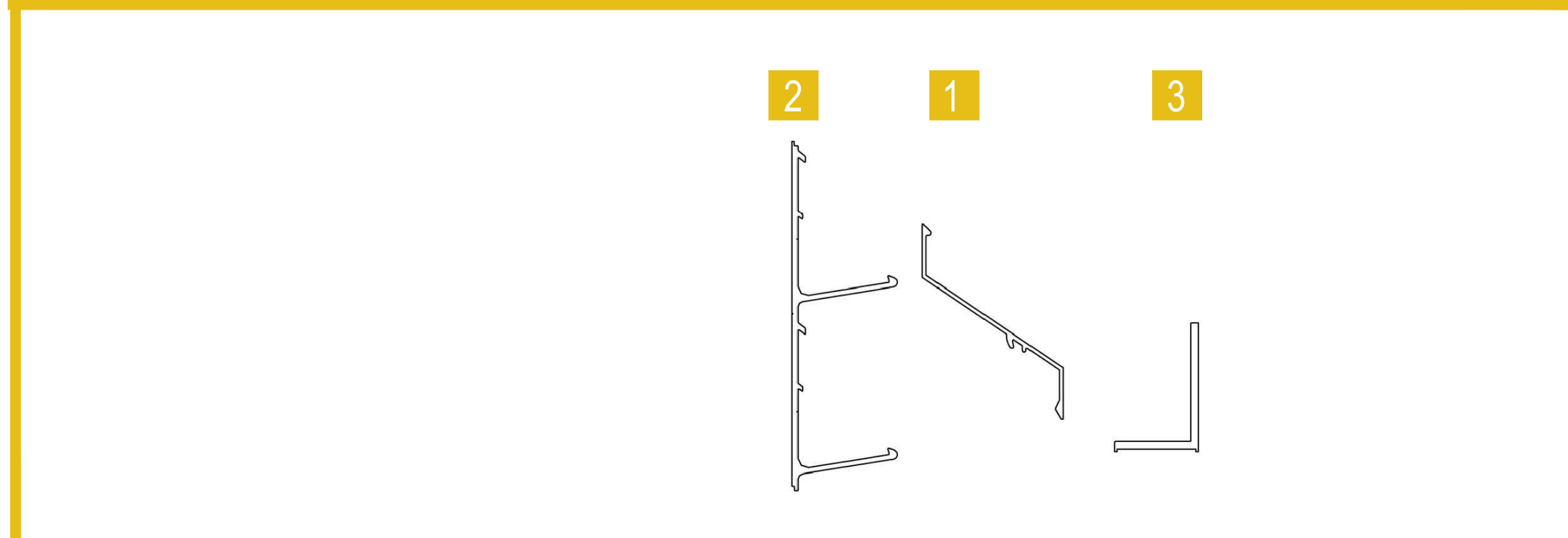
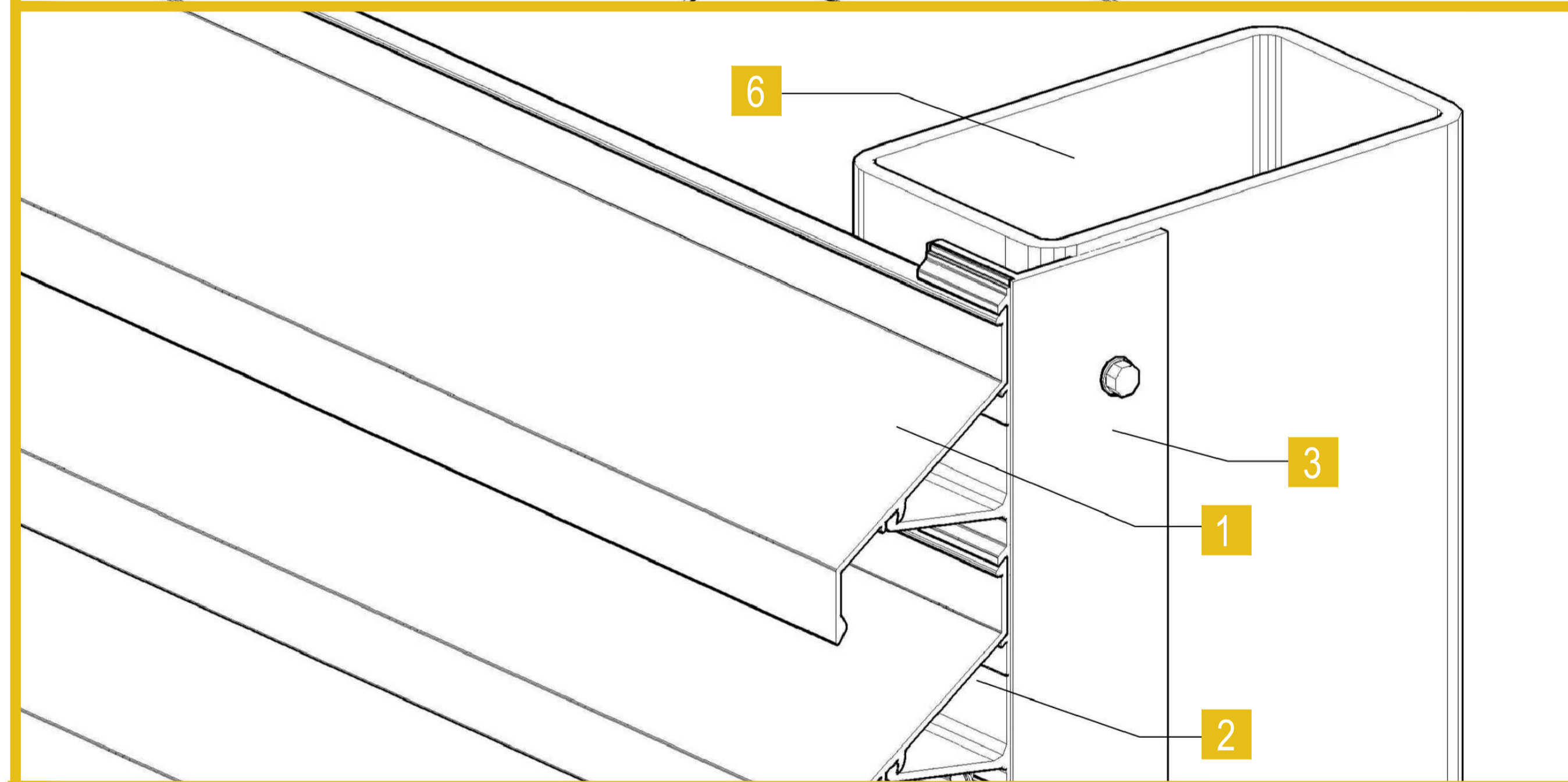
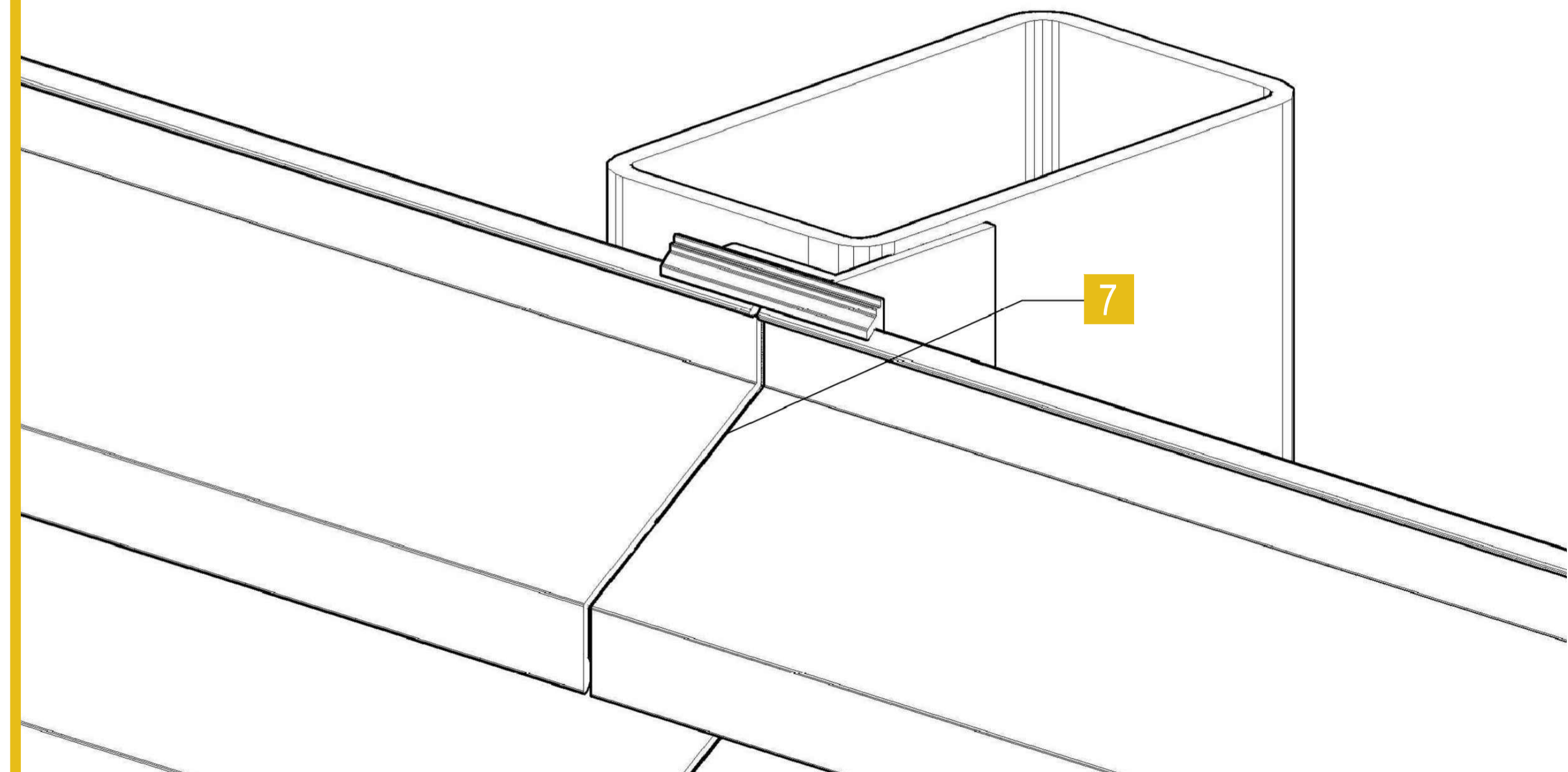
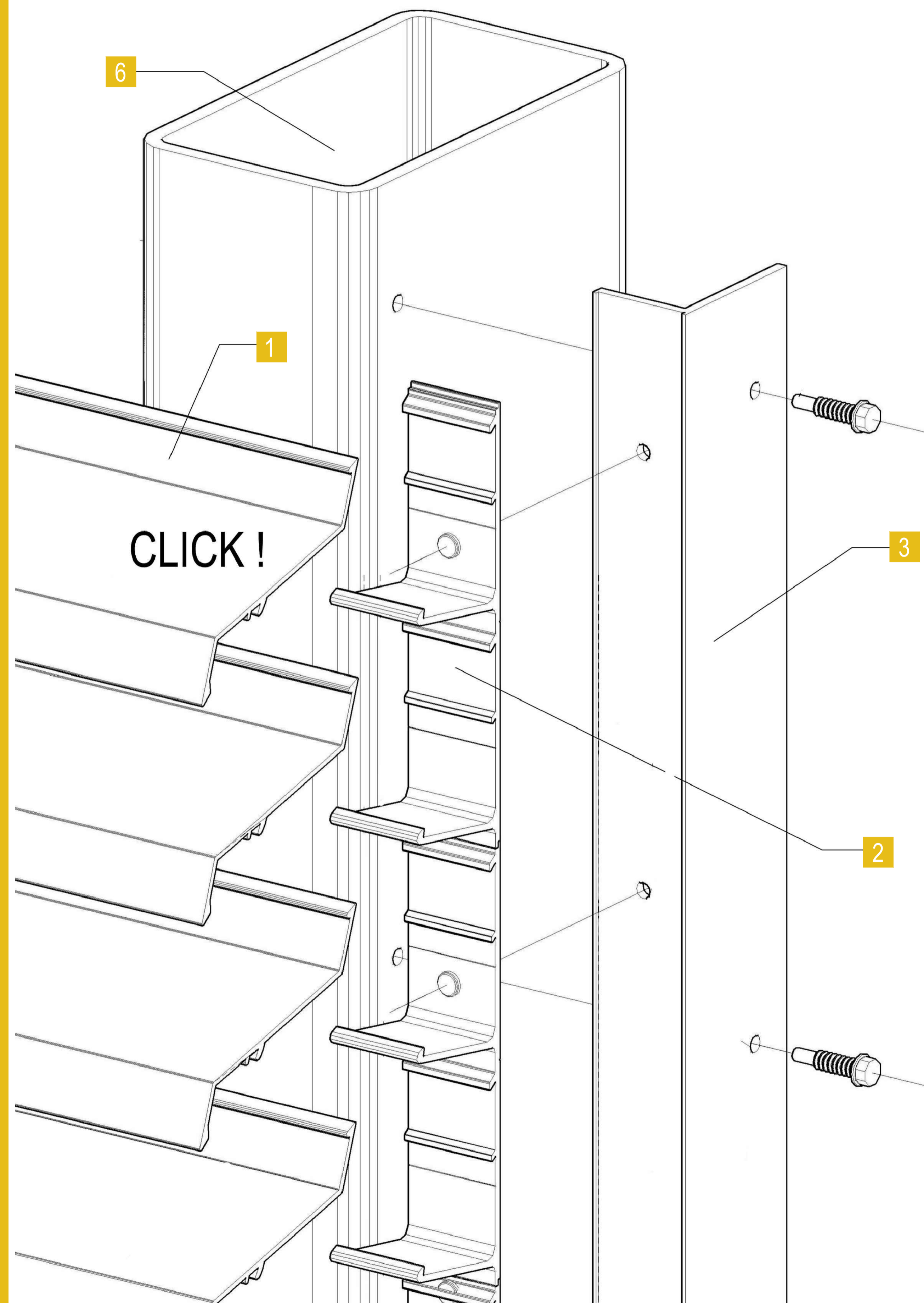
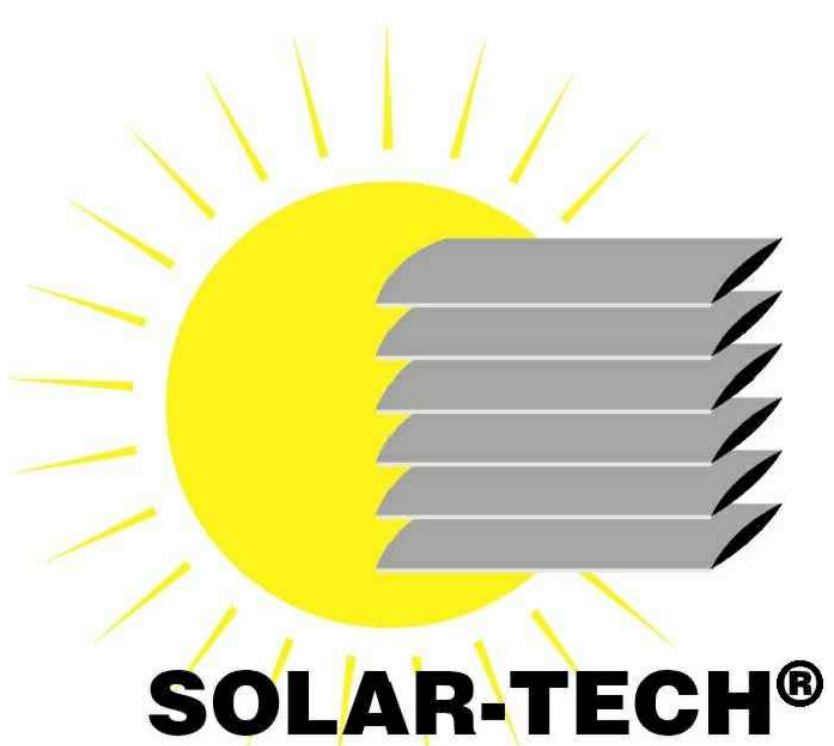
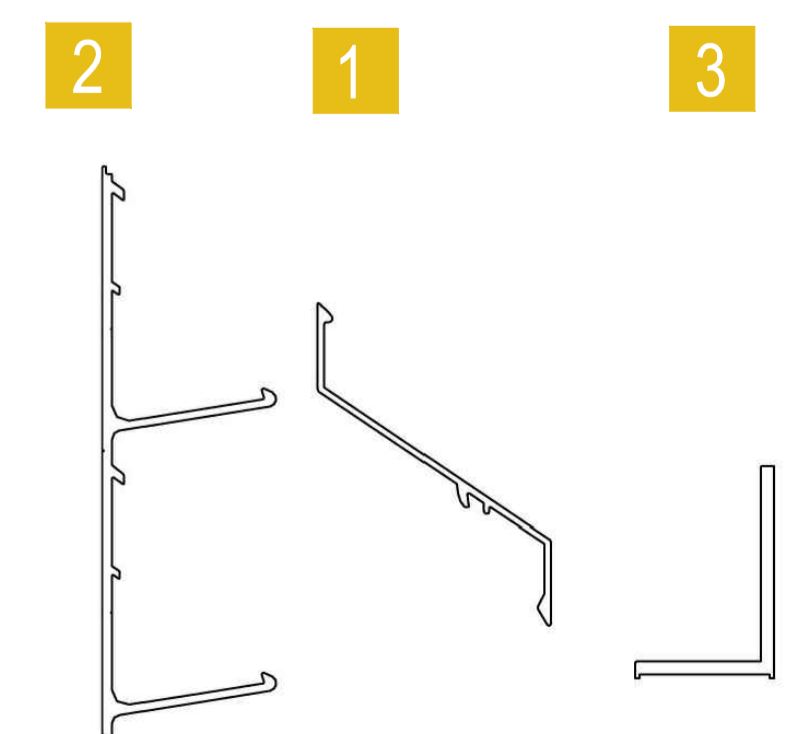
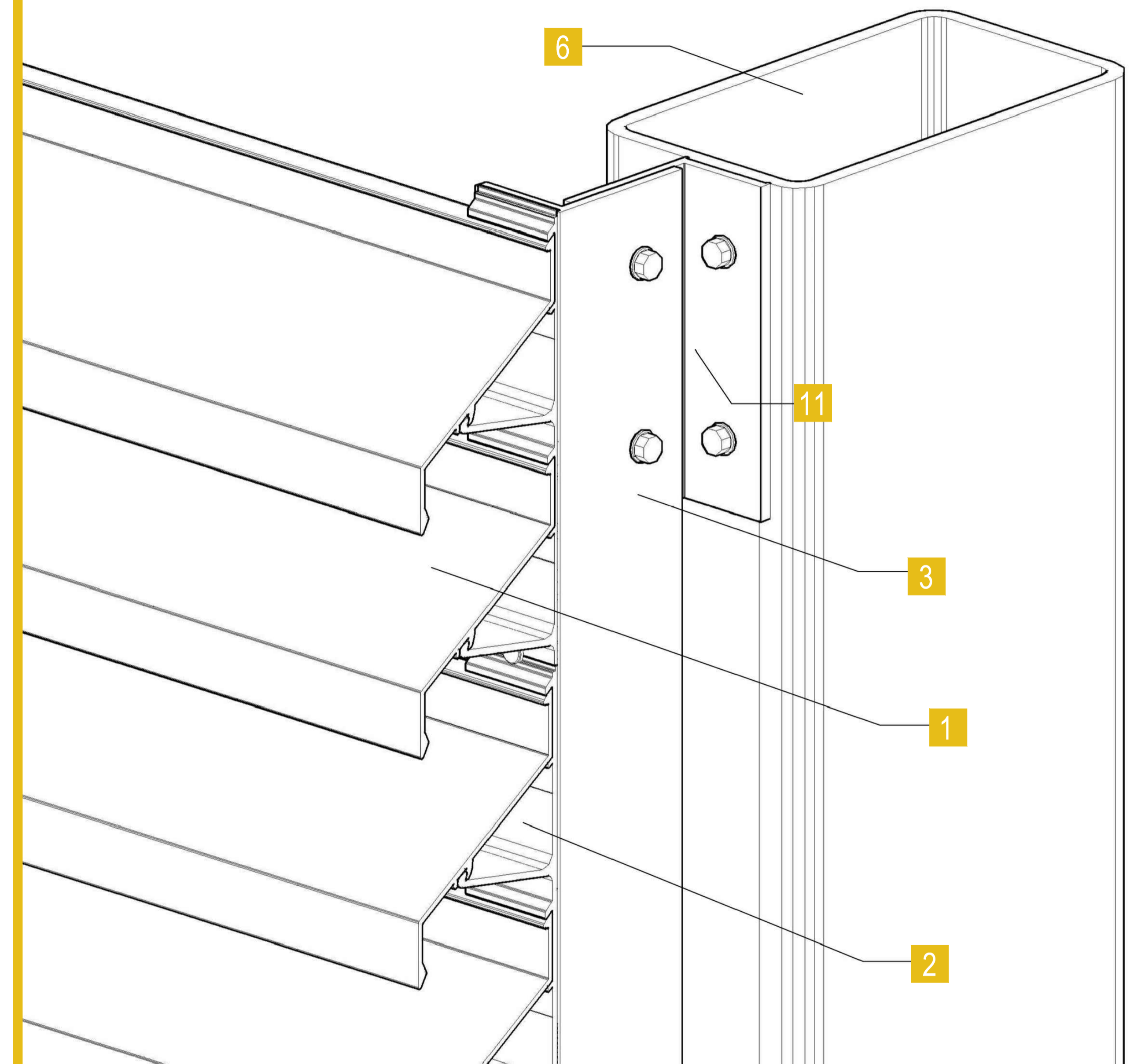
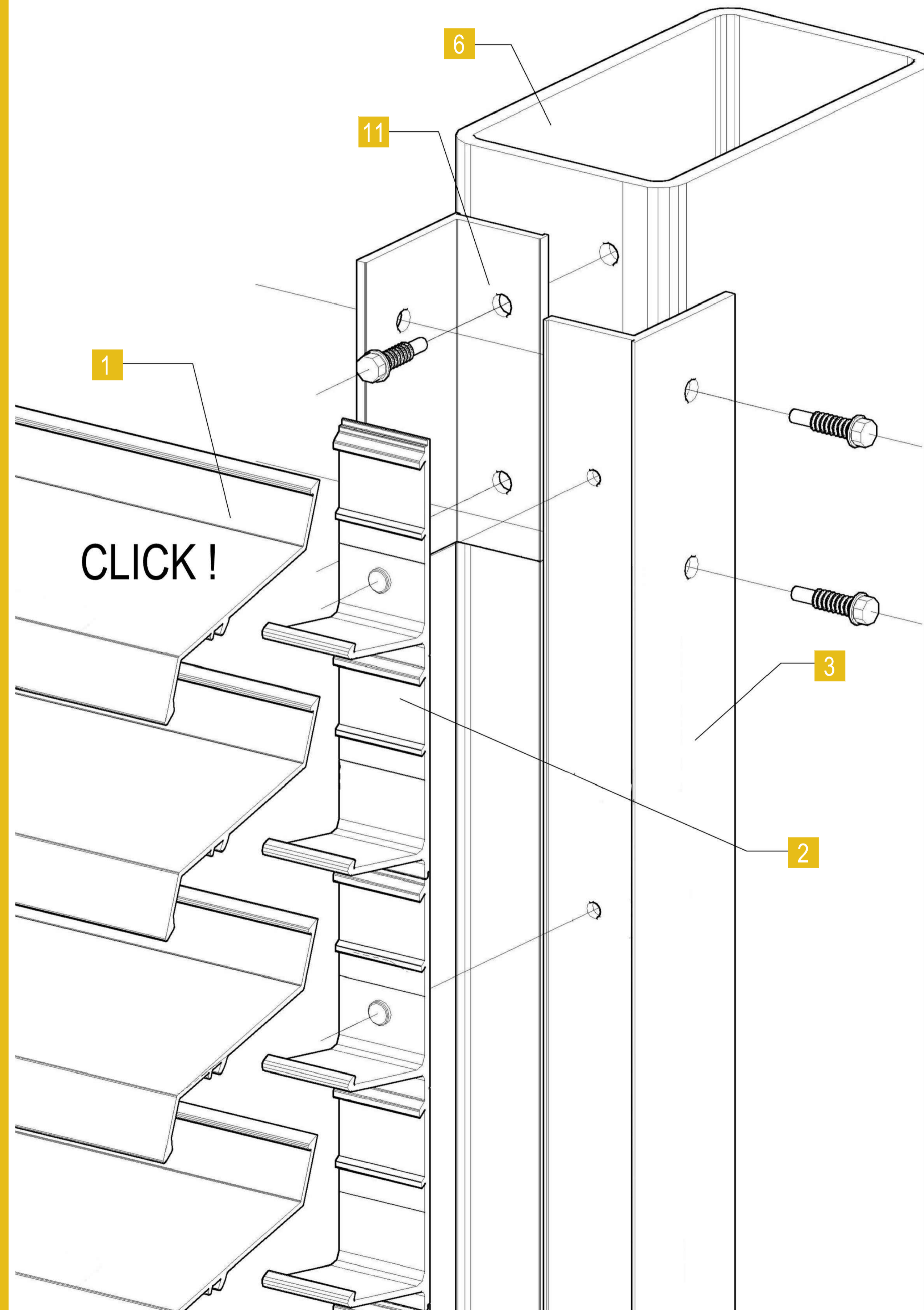

- 1 Aluminum profile Solar - Tech ST 67Z
- 2 Aluminum profile Solar - Tech ST 67ZG (GRIP)
- 3 Aluminum profile Solar - Tech ST L50Z
- 4 Load bearing bracket
- 5 Bracket for sliding connections
- 6 Steel post/pole
- 7 Dilatation 1 - 1,5 mm/m
- 8 Spacer
- 9 Welded bracket
- 10 Weld
- 11 Aluminum bracket

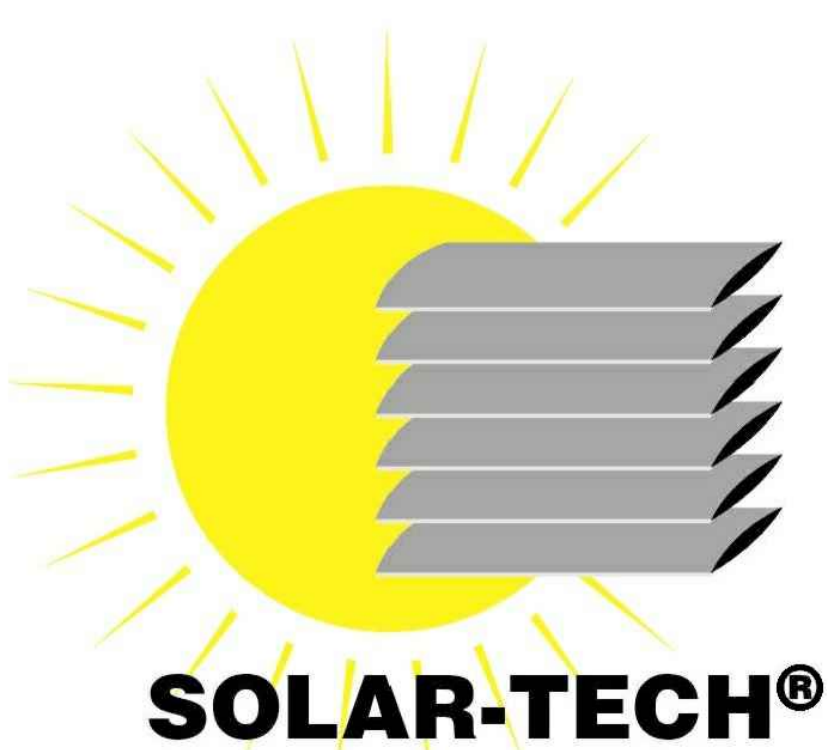
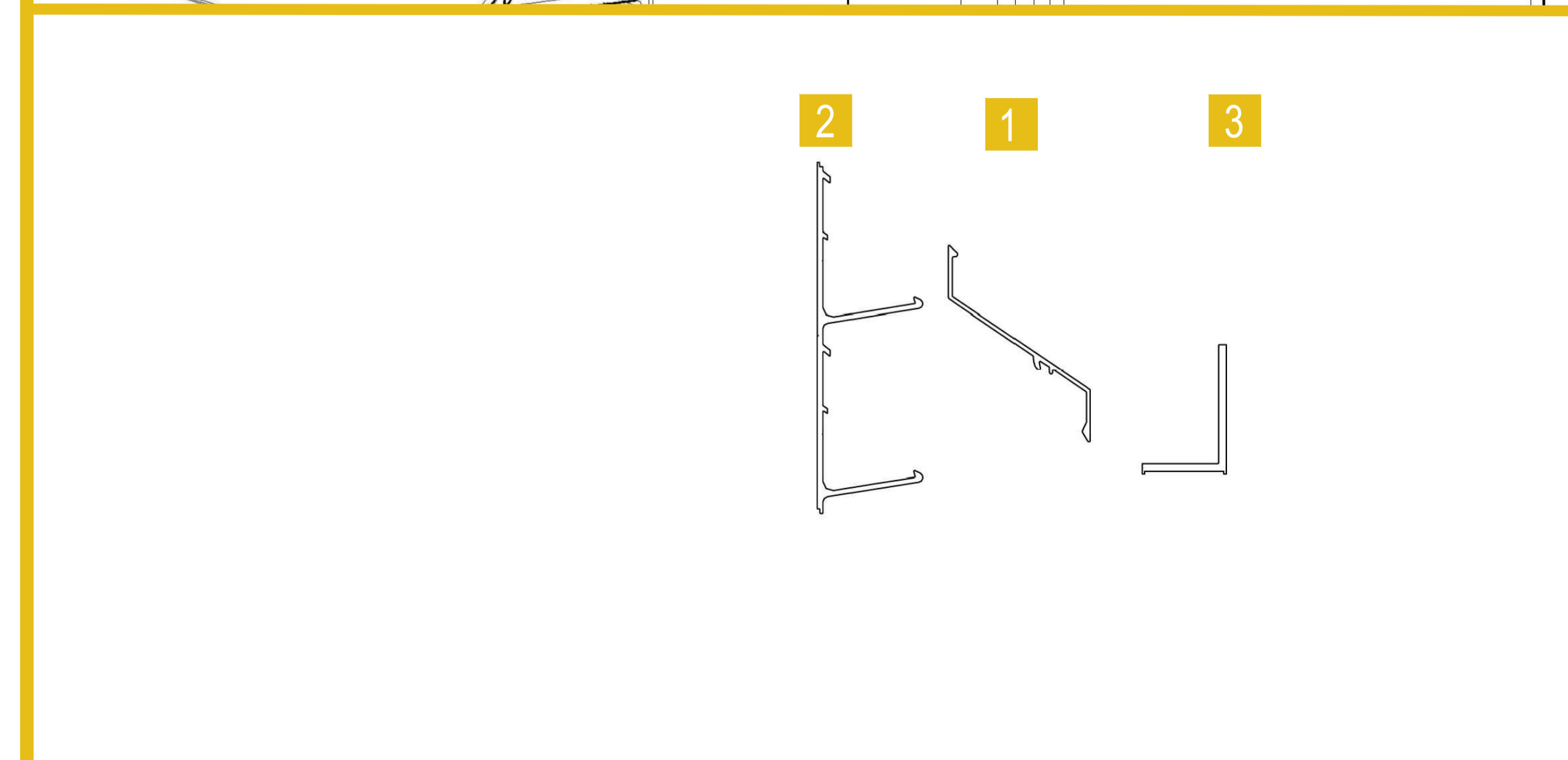
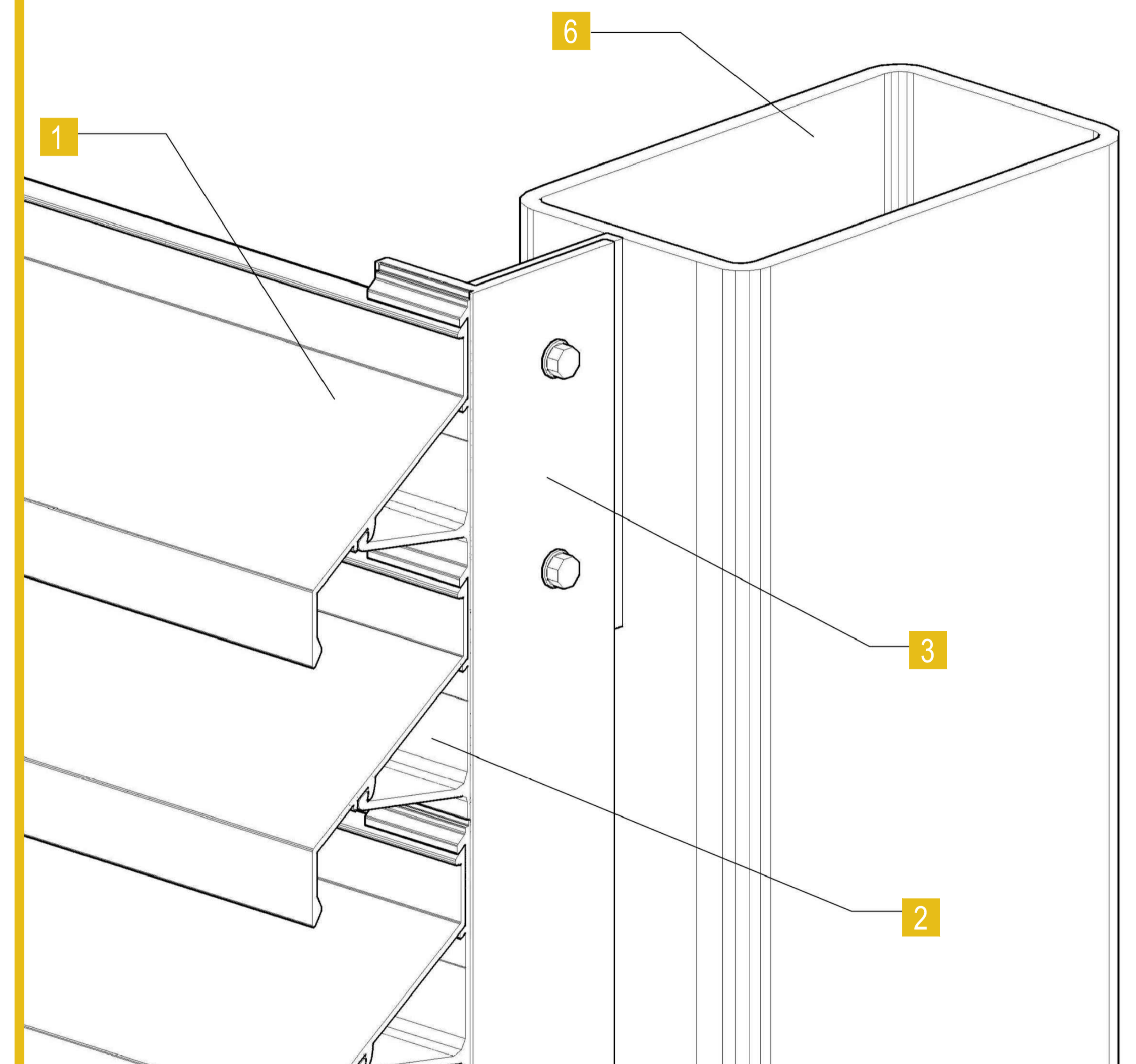
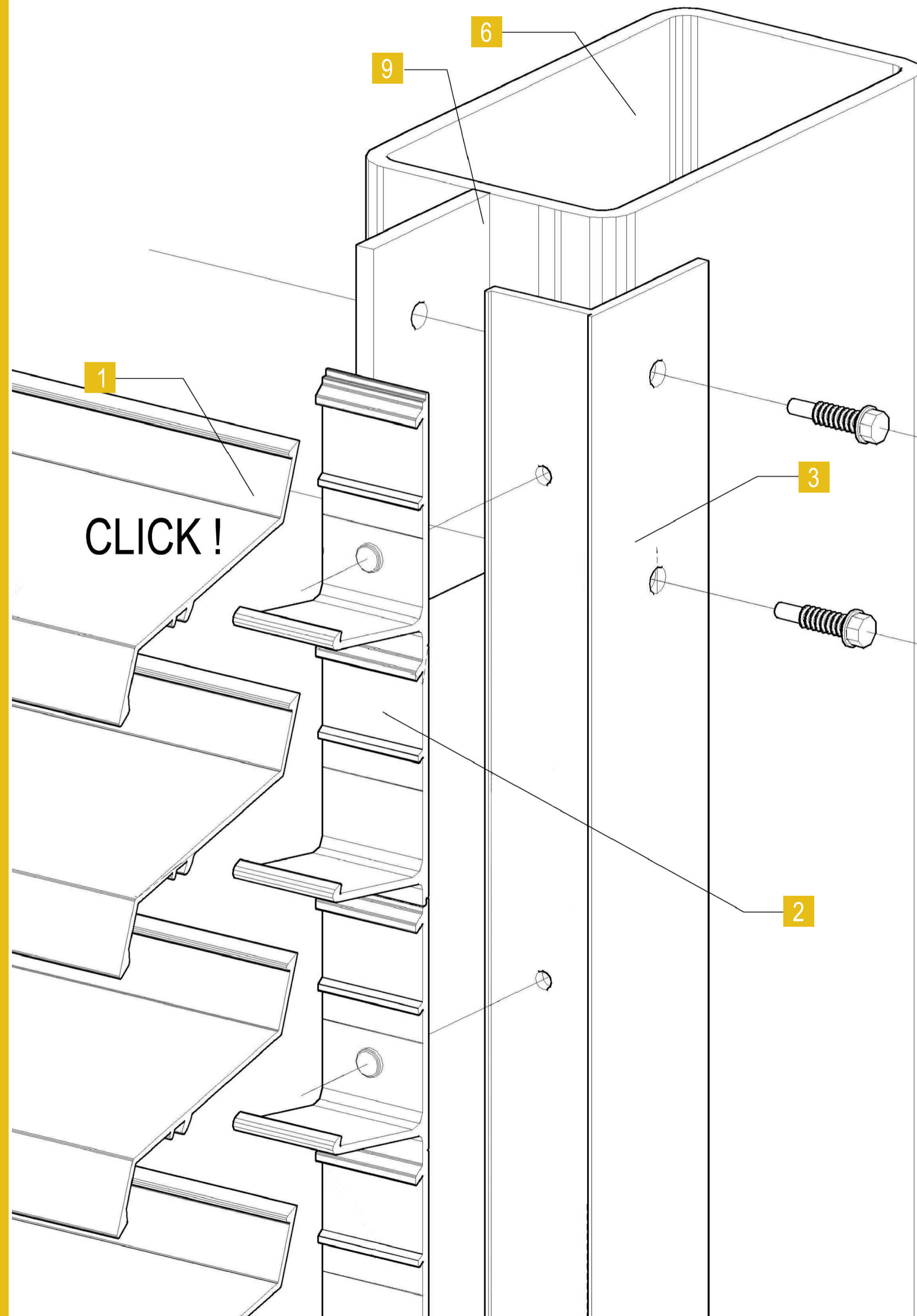

- 1 Aluminum profile Solar - Tech ST 67Z
- 2 Aluminum profile Solar - Tech ST 67ZG (GRIP)
- 3 Aluminum profile Solar - Tech ST L50Z
- 4 Load bearing bracket
- 5 Bracket for sliding connections
- 6 Steel post/pole
- 7 Dilatation 1 - 1,5 mm/m
- 8 Spacer
- 9 Welded bracket
- 10 Weld
- 11 Aluminum bracket

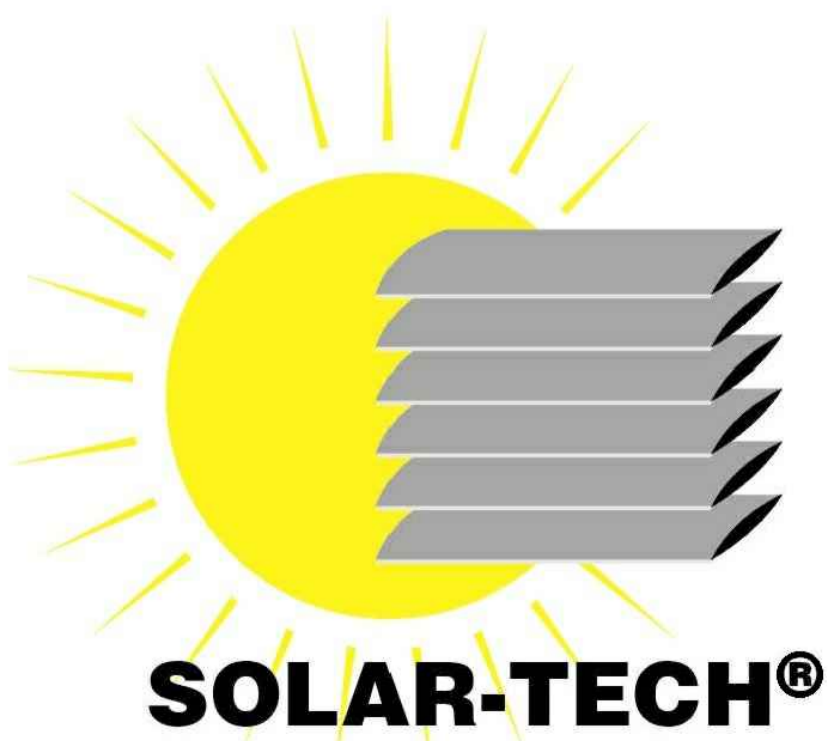
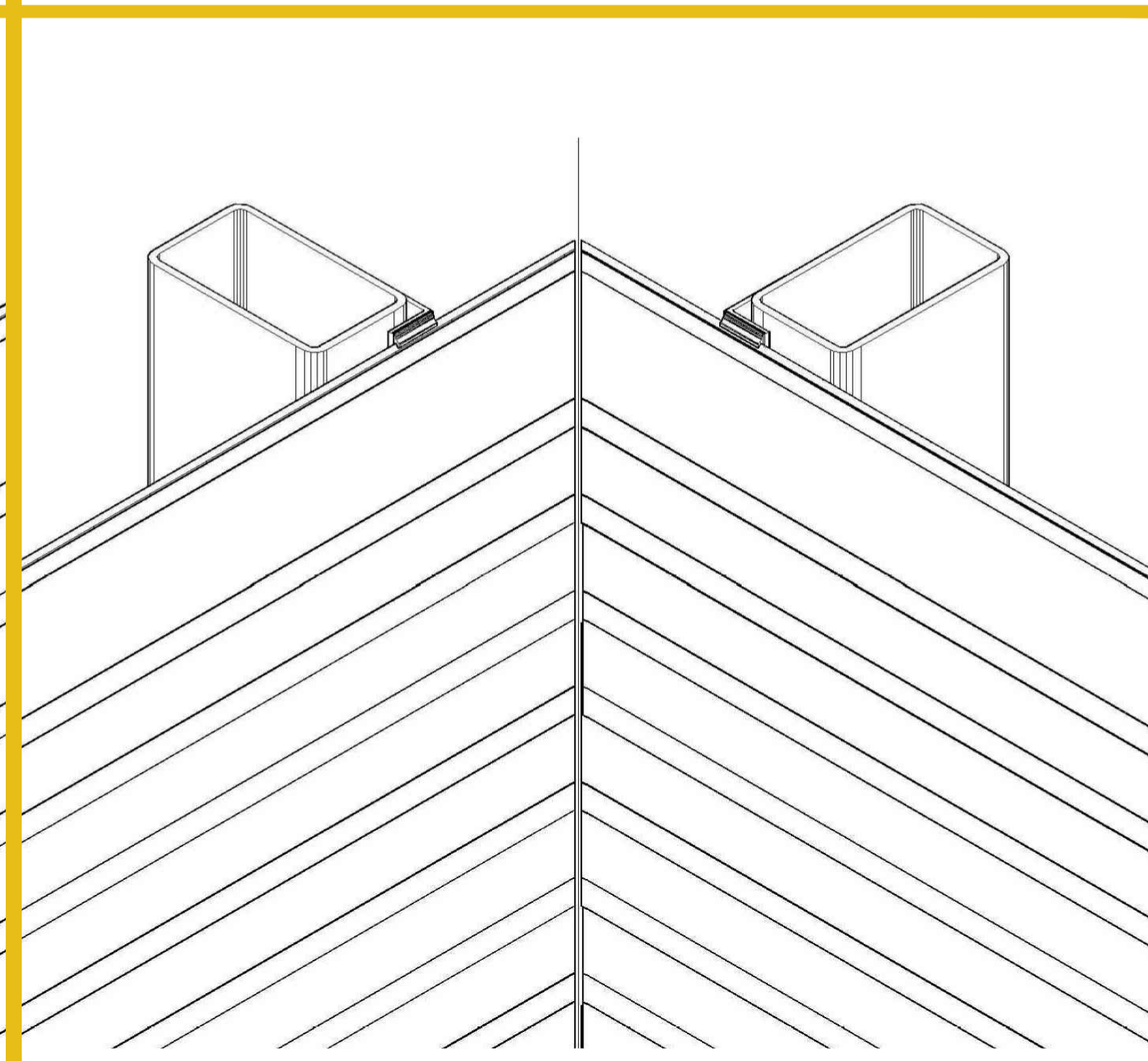
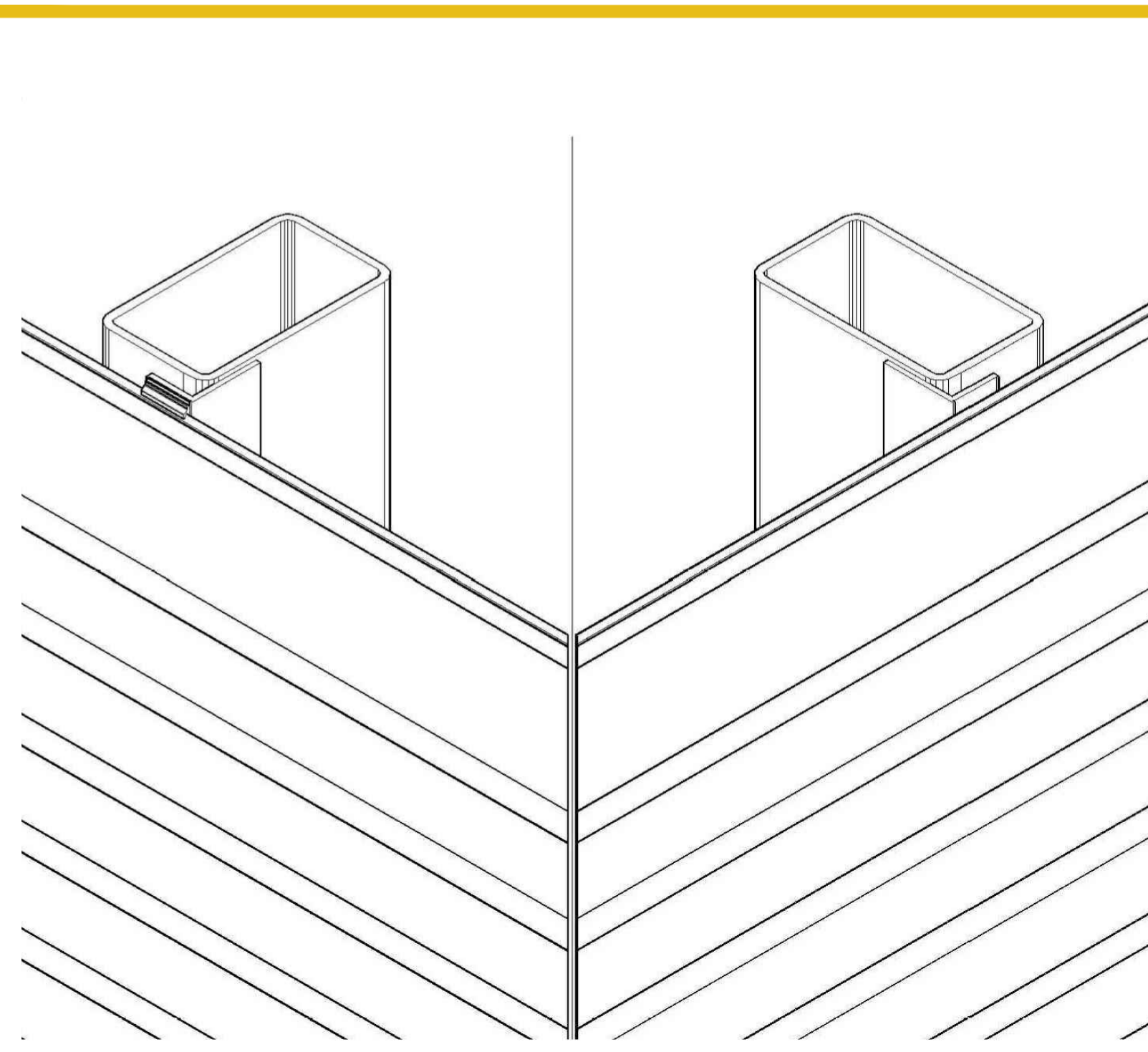
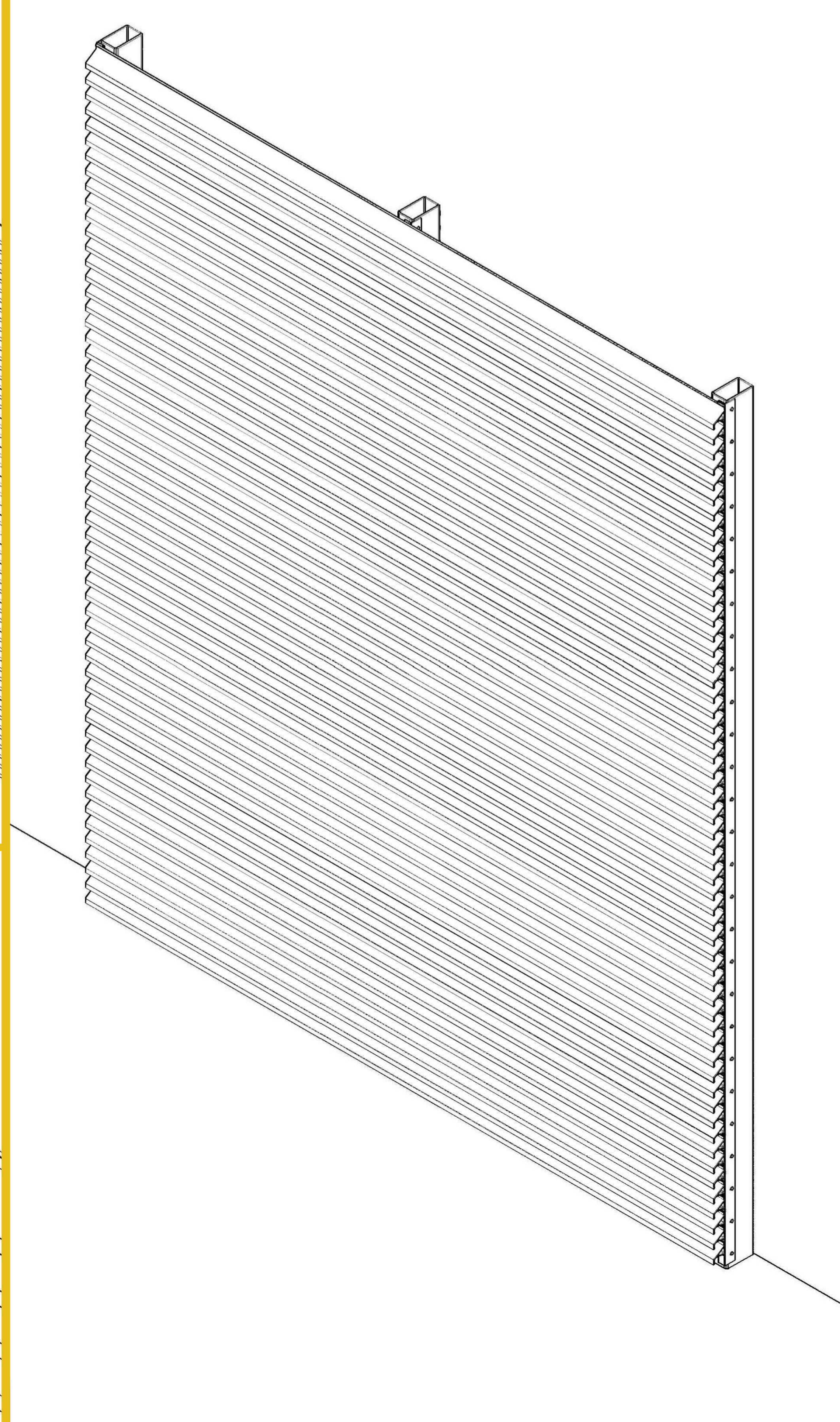
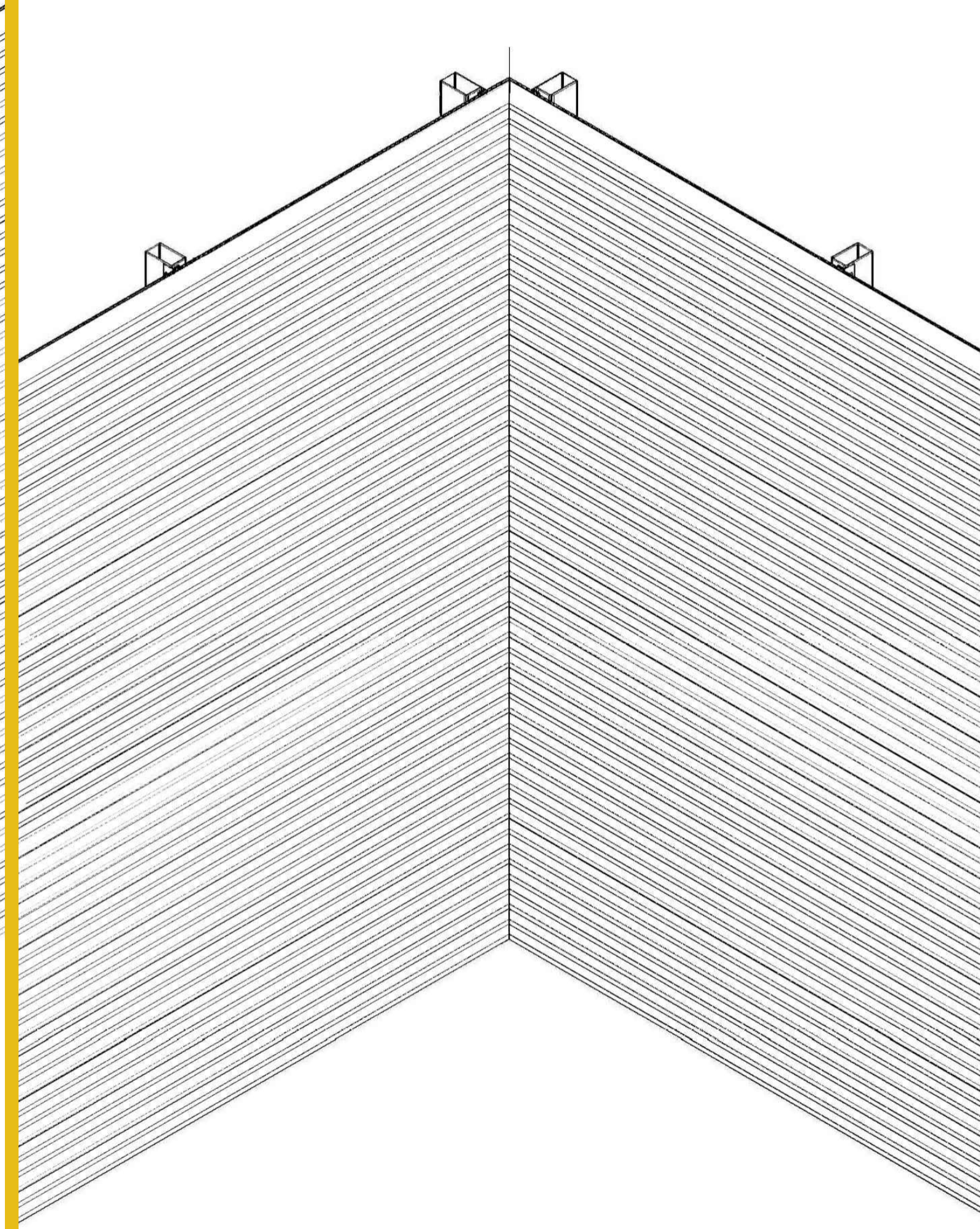
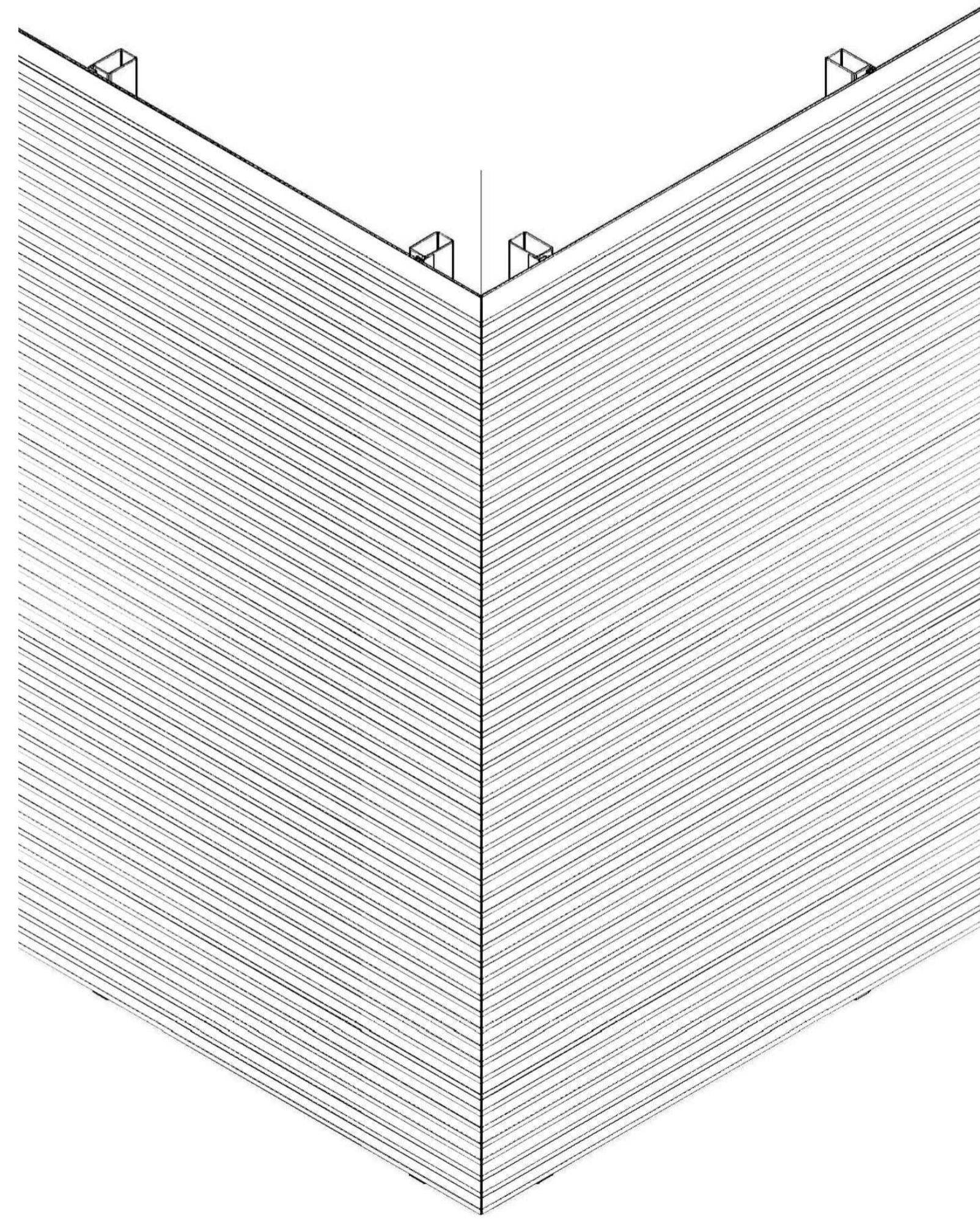

- 1 Aluminum profile Solar - Tech ST 67Z
- 2 Aluminum profile Solar - Tech ST 67ZG(GRIP)
- 3 Aluminum profile Solar - Tech ST L50Z
- 4 Load bearing bracket
- 5 Bracket for sliding connections
- 6 Steel post/pole
- 7 Dilatation 1 - 1,5 mm/m
- 8 Spacer
- 9 Welded bracket
- 10 Weld
- 11 Aluminum bracket

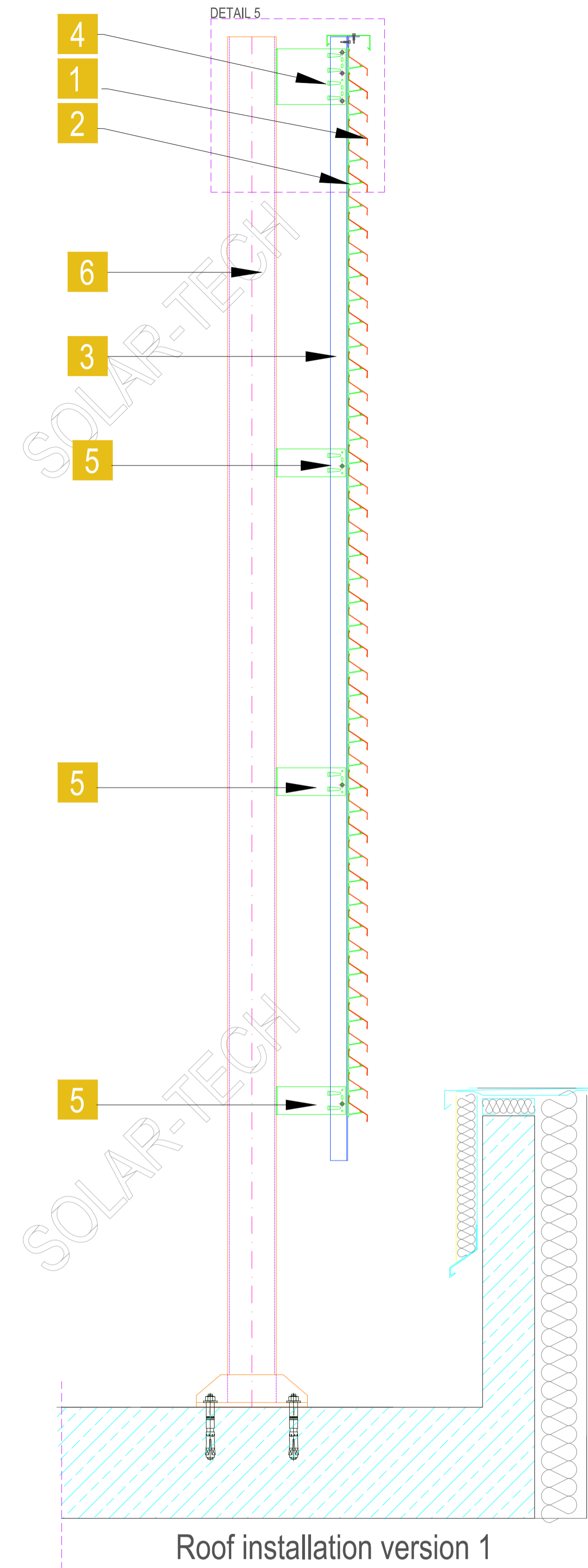
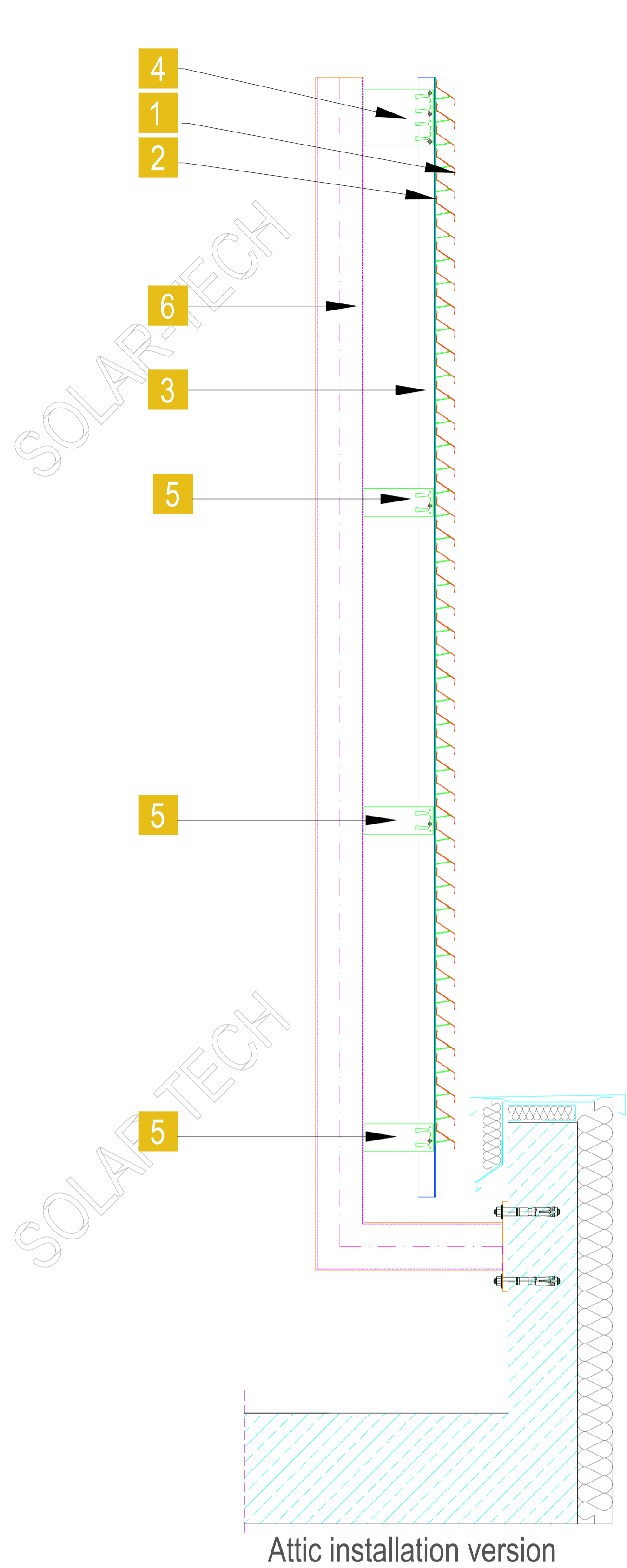

DETAIL 5.
Top covering

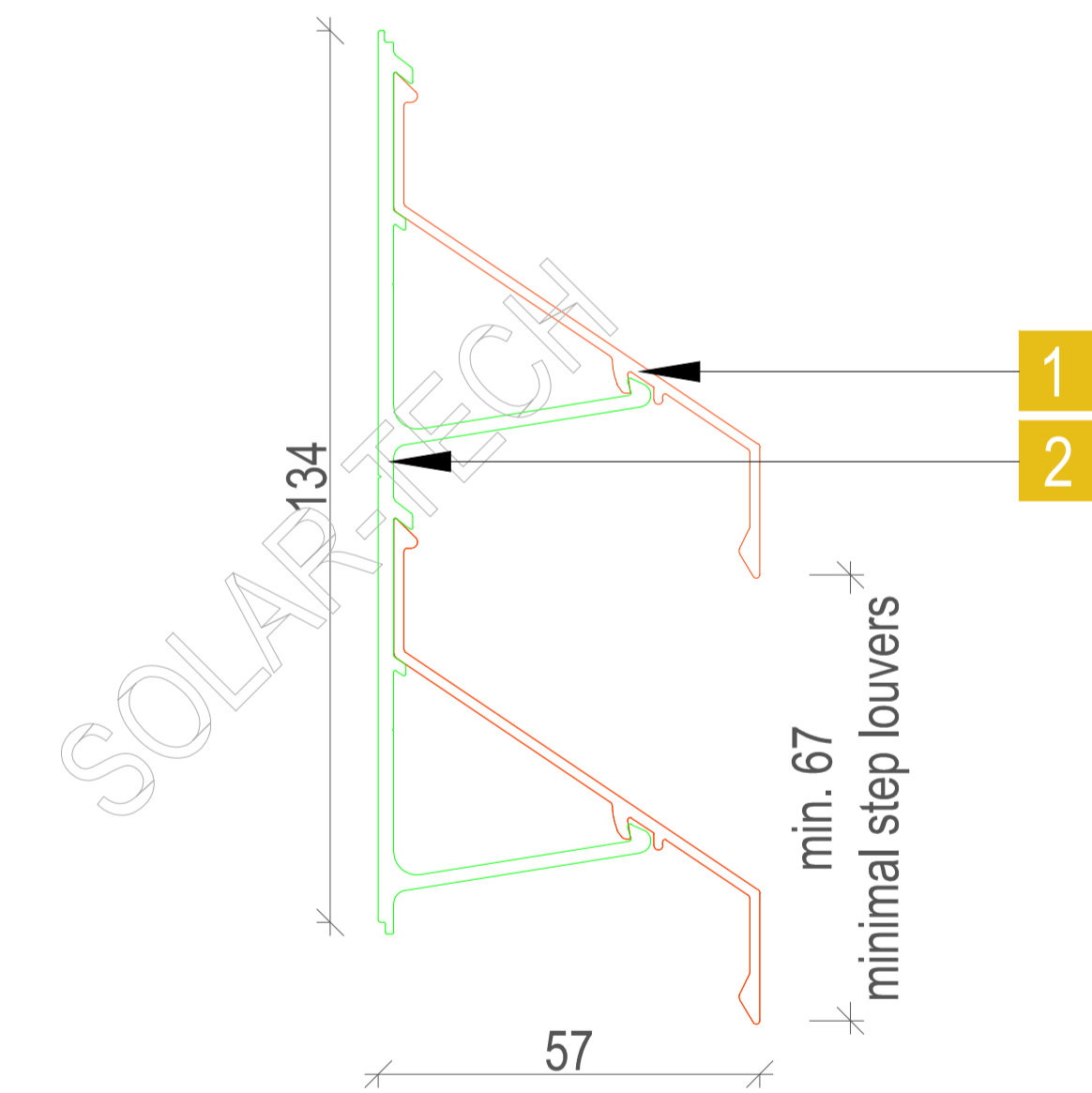
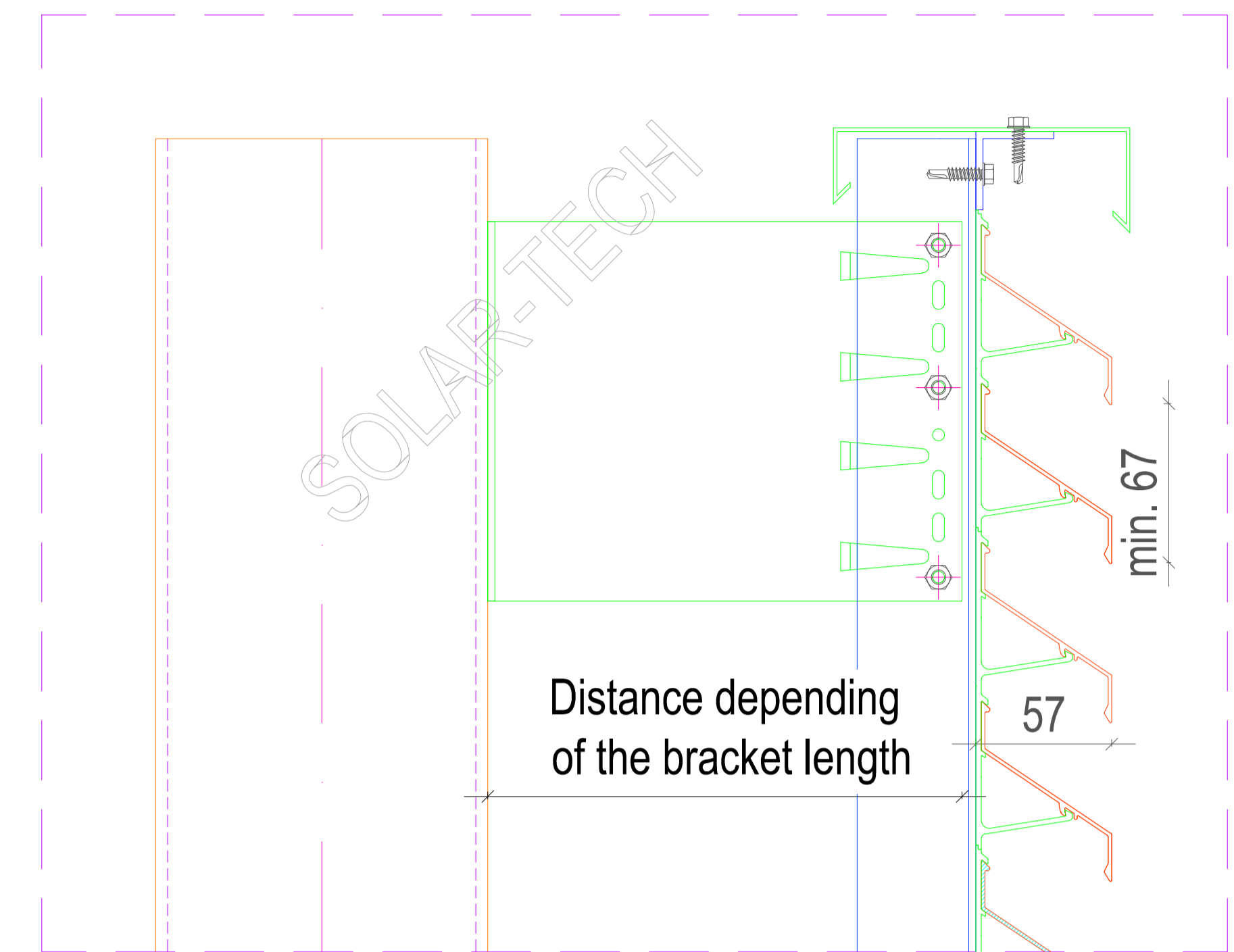

CAUTION!

Presented solutions are only a sample. In any doubts, please contact the Solar - Tech company. Pole and beams shape and sizes according to the technical calculation.

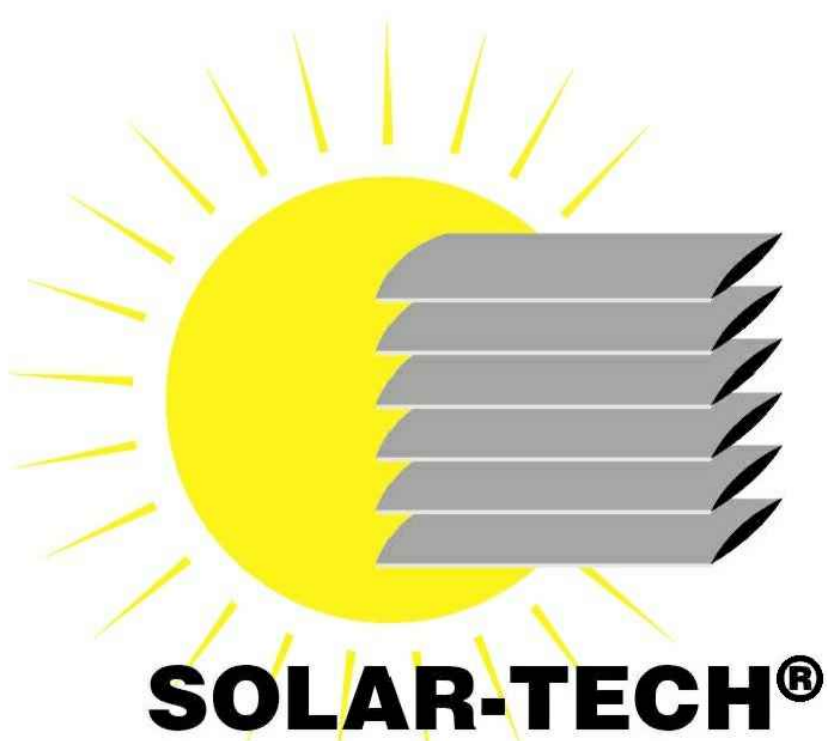

- 1 Aluminum profile Solar - Tech ST 67Z
- 2 Aluminum profile Solar - Tech ST 67ZG(GRIP)
- 3 Aluminum profile Solar - Tech ST L50Z
- 4 Load bearing bracket
- 5 Bracket for sliding connections
- 6 Steel post/pole
- 7 Dilatation 1 - 1,5 mm/m
- 8 Spacer
- 9 Welded bracket
- 10 Weld
- 11 Aluminum bracket

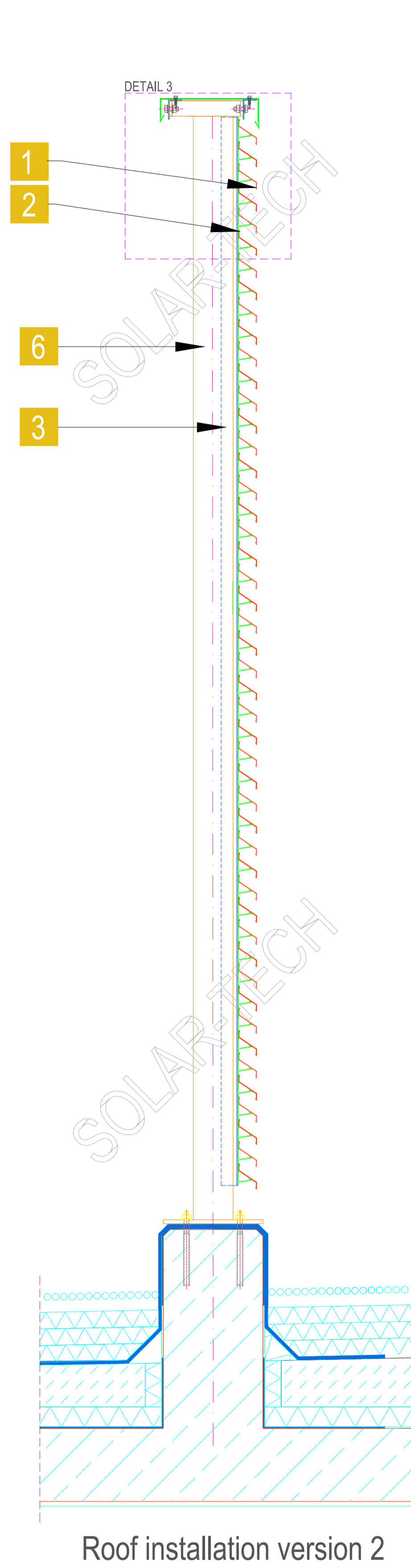

Roof installation version 2

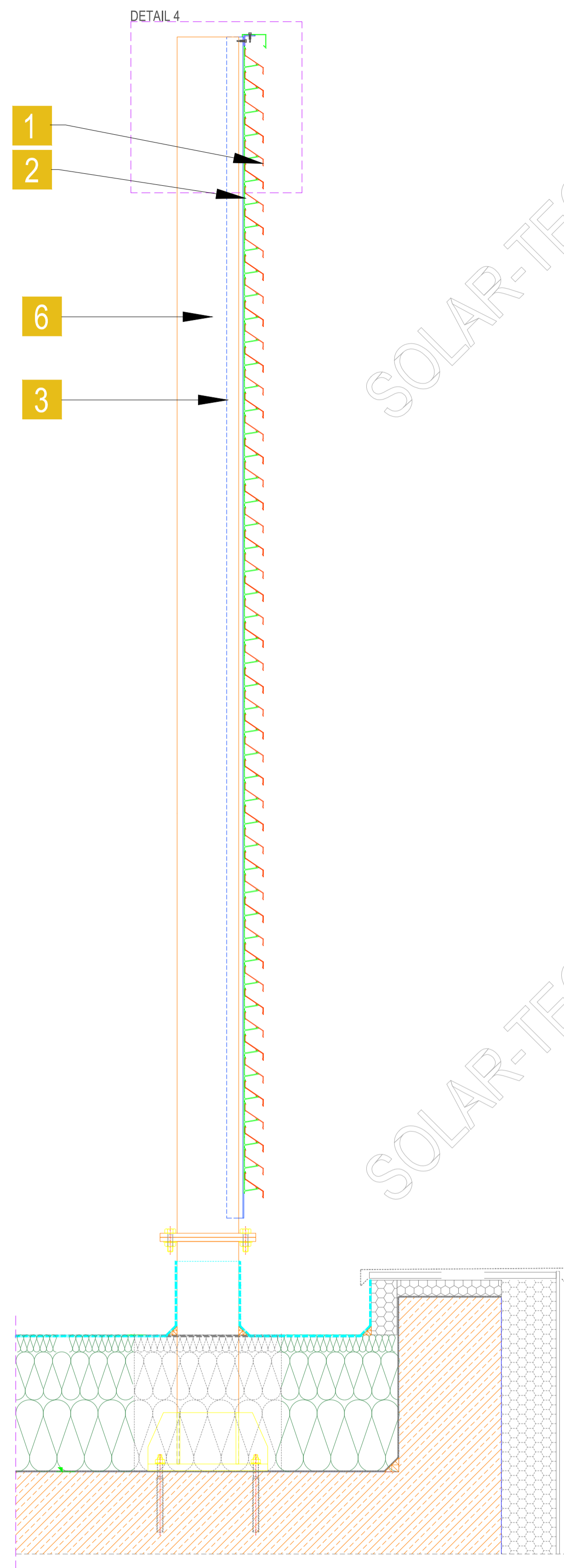

Roof installation version 3
Steel construction divided.

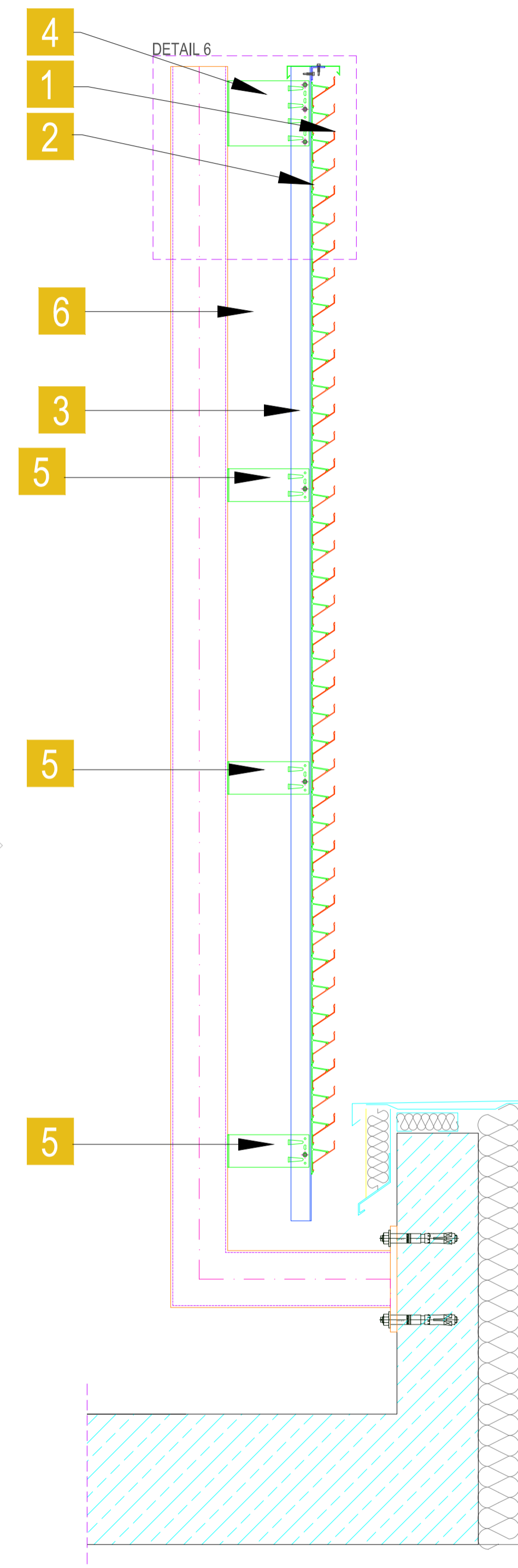

Attic installation version

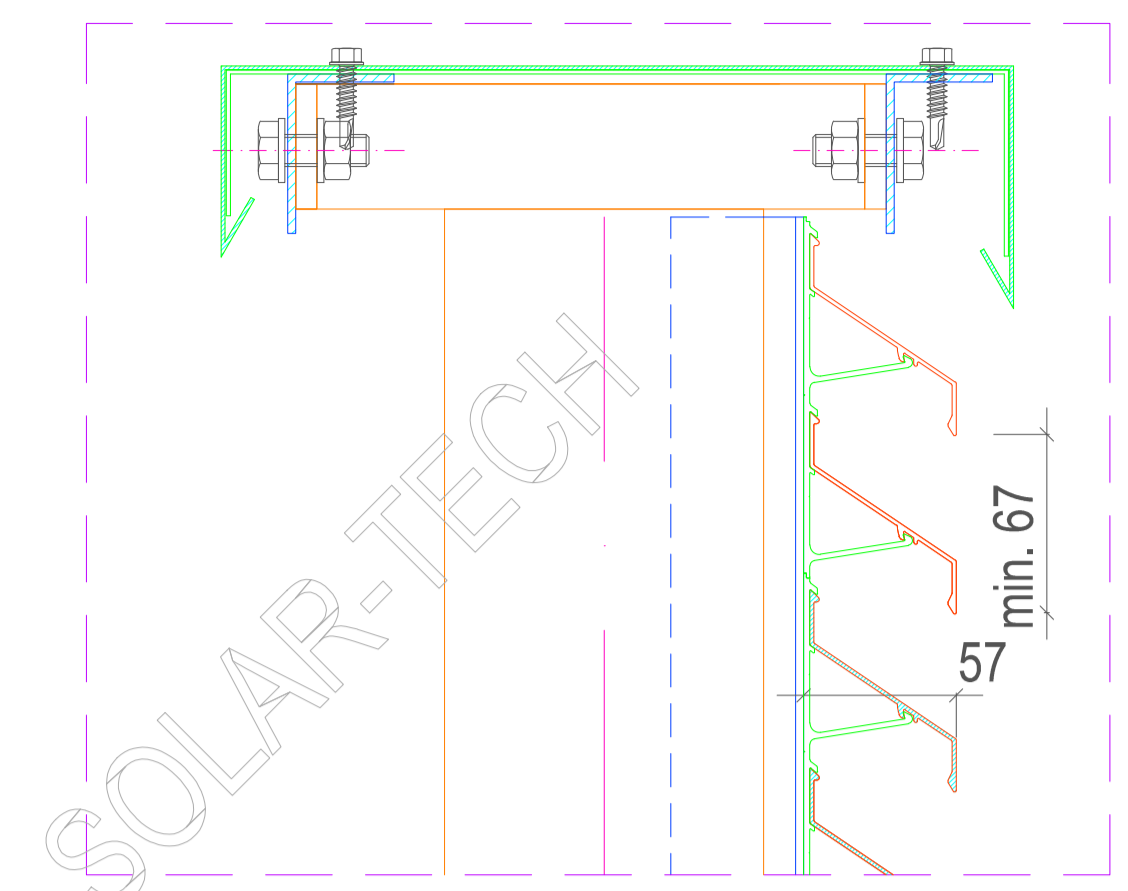

DETAIL 3.
Covering ver. 1

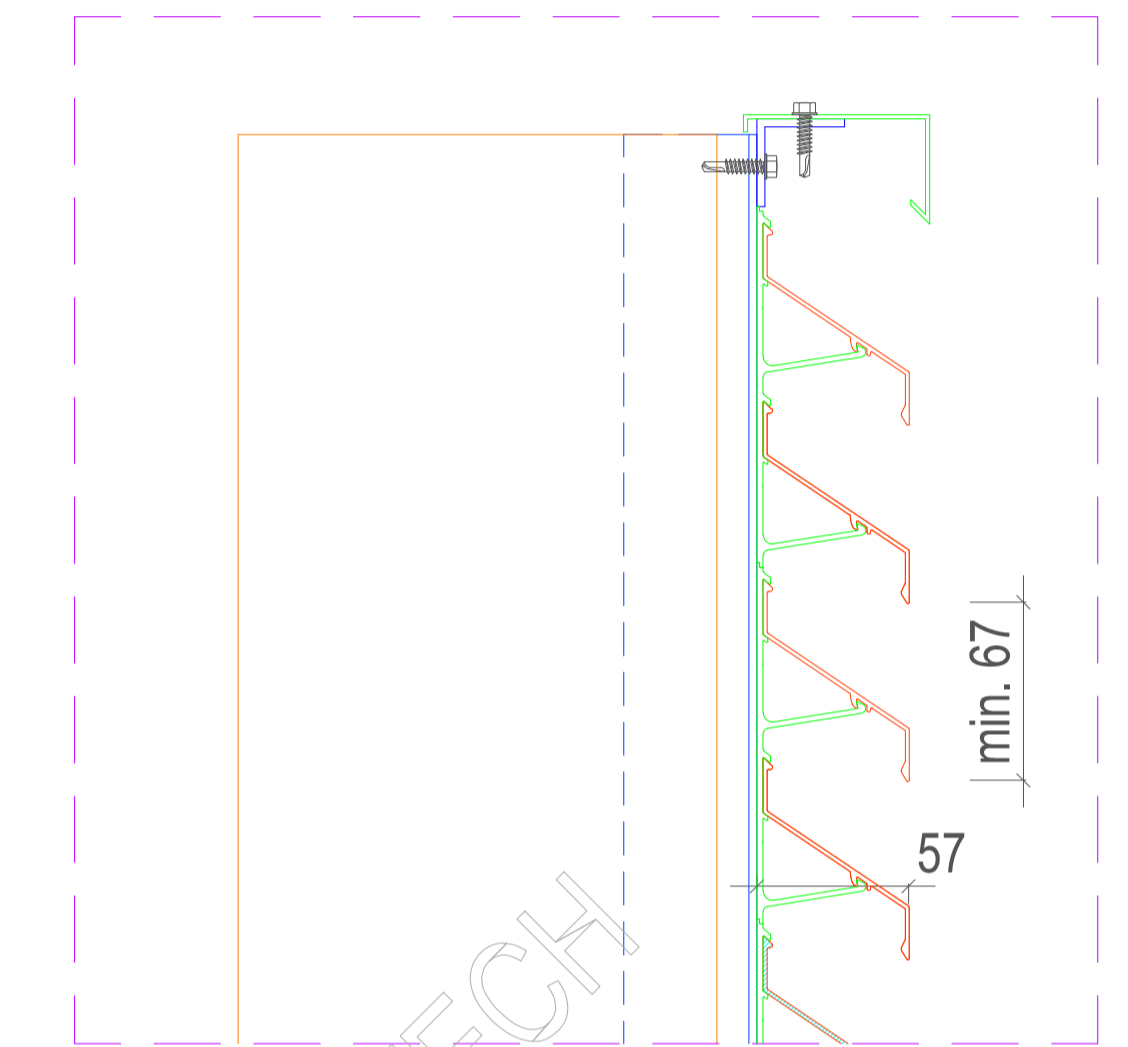

DETAIL 4.
Covering ver. 2

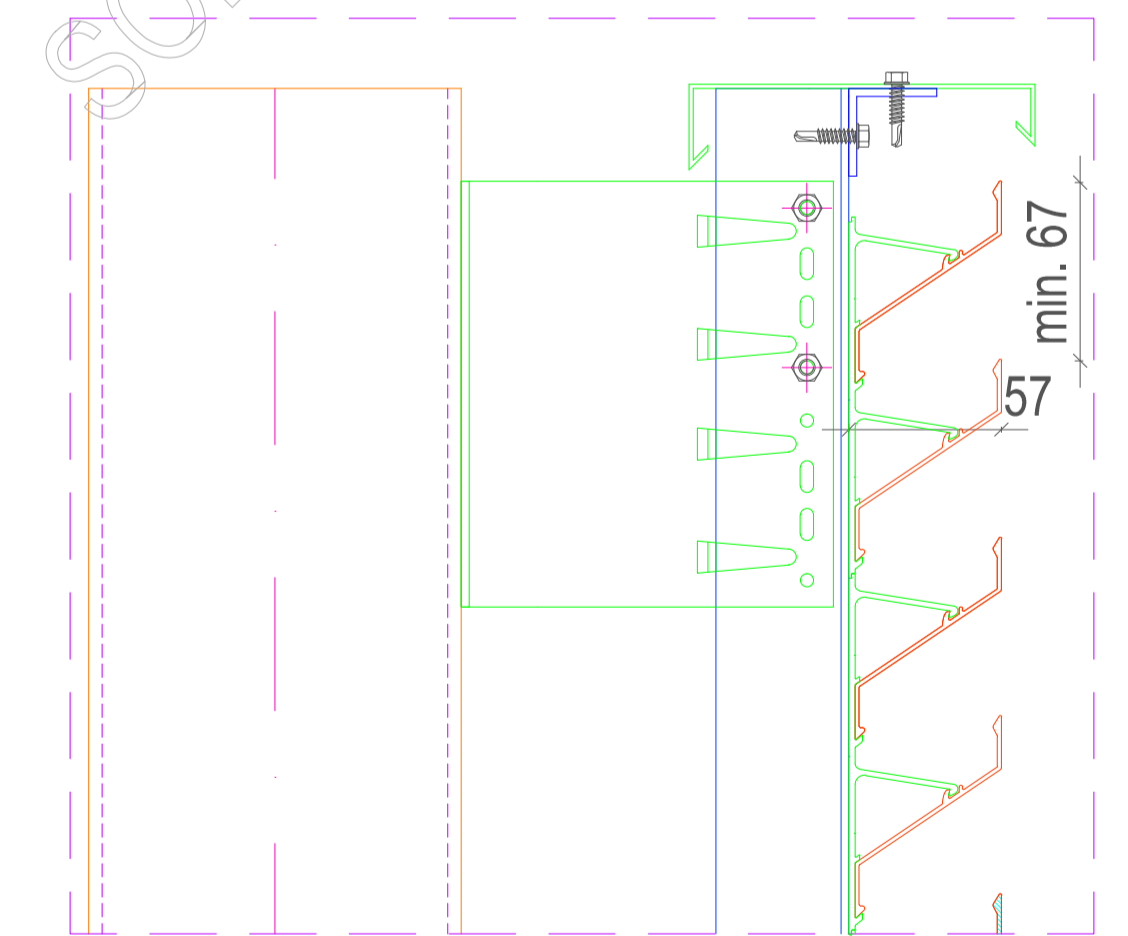

DETAIL 6.
Covering ver. 3
and installation "upside down".

CAUTION!

Presented solutions are only a sample. In any doubts, please contact the Solar - Tech company. Pole and beams shape and sizes according to the technical calculation.

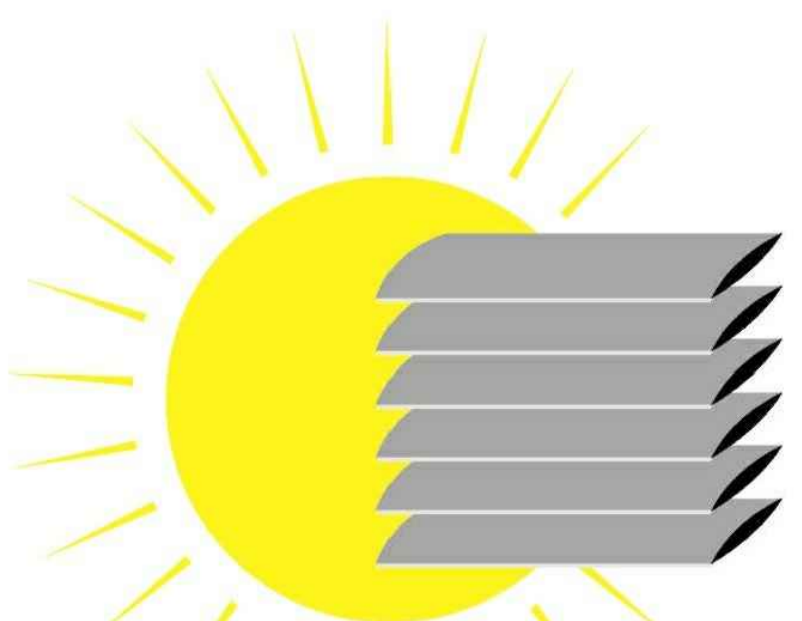

SOLAR-TECH®

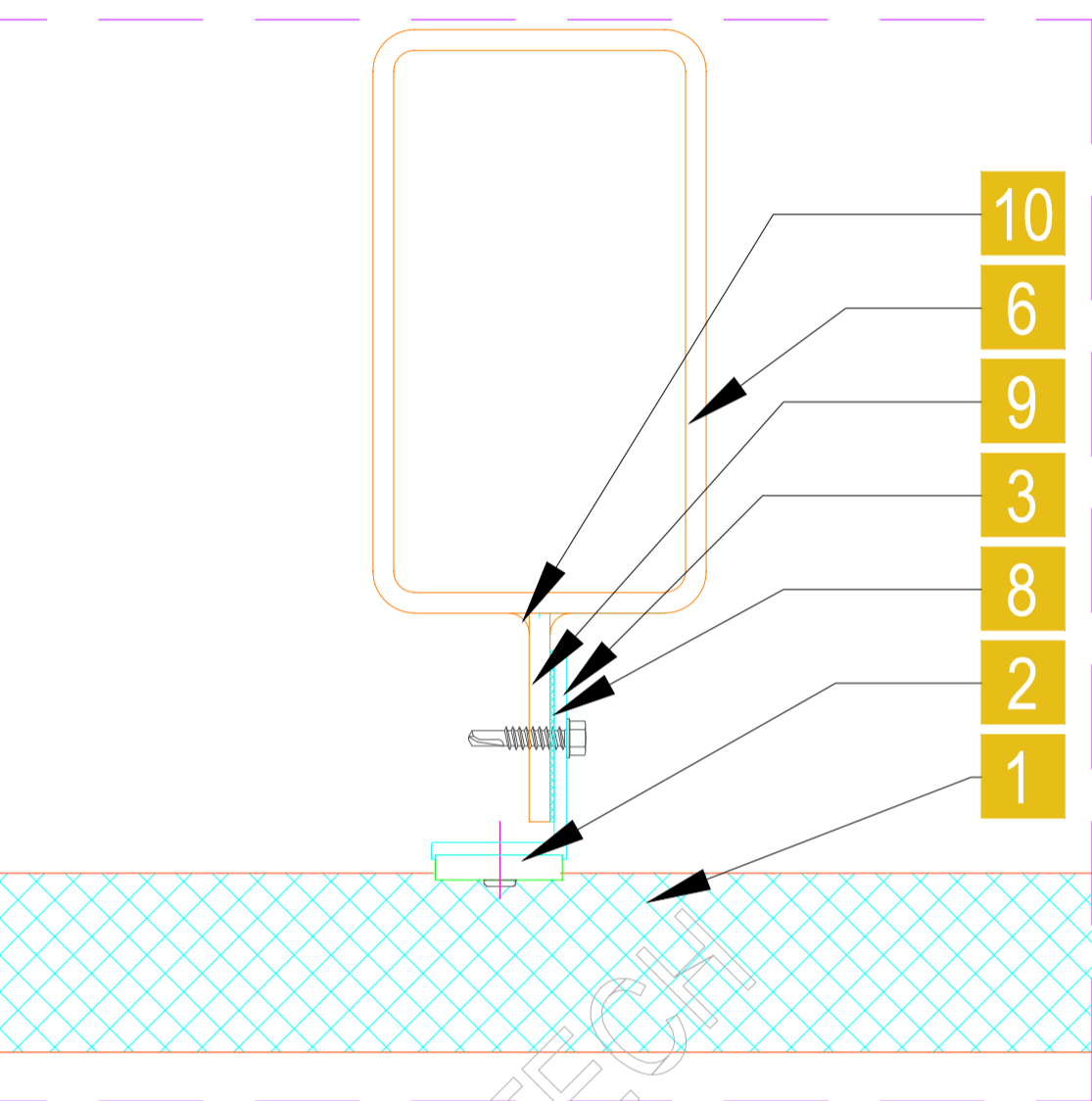
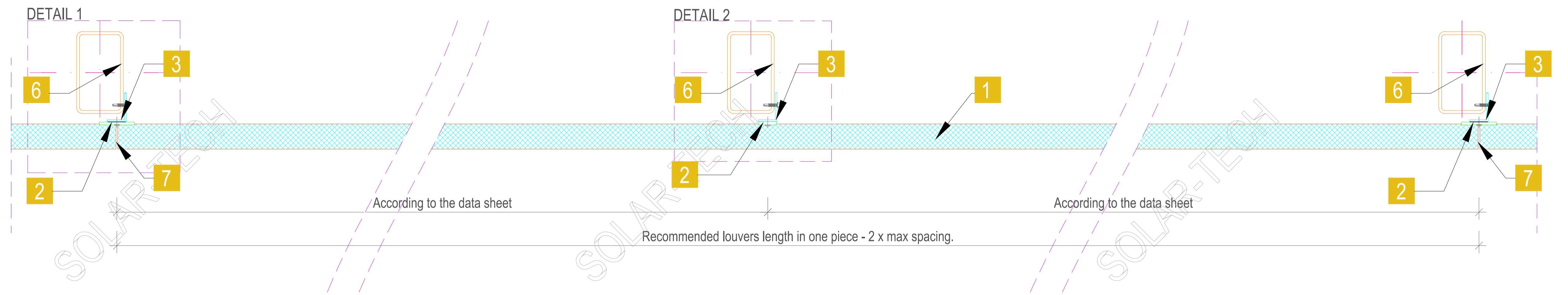

DETAIL 2 Option 1.
Welded bracket.

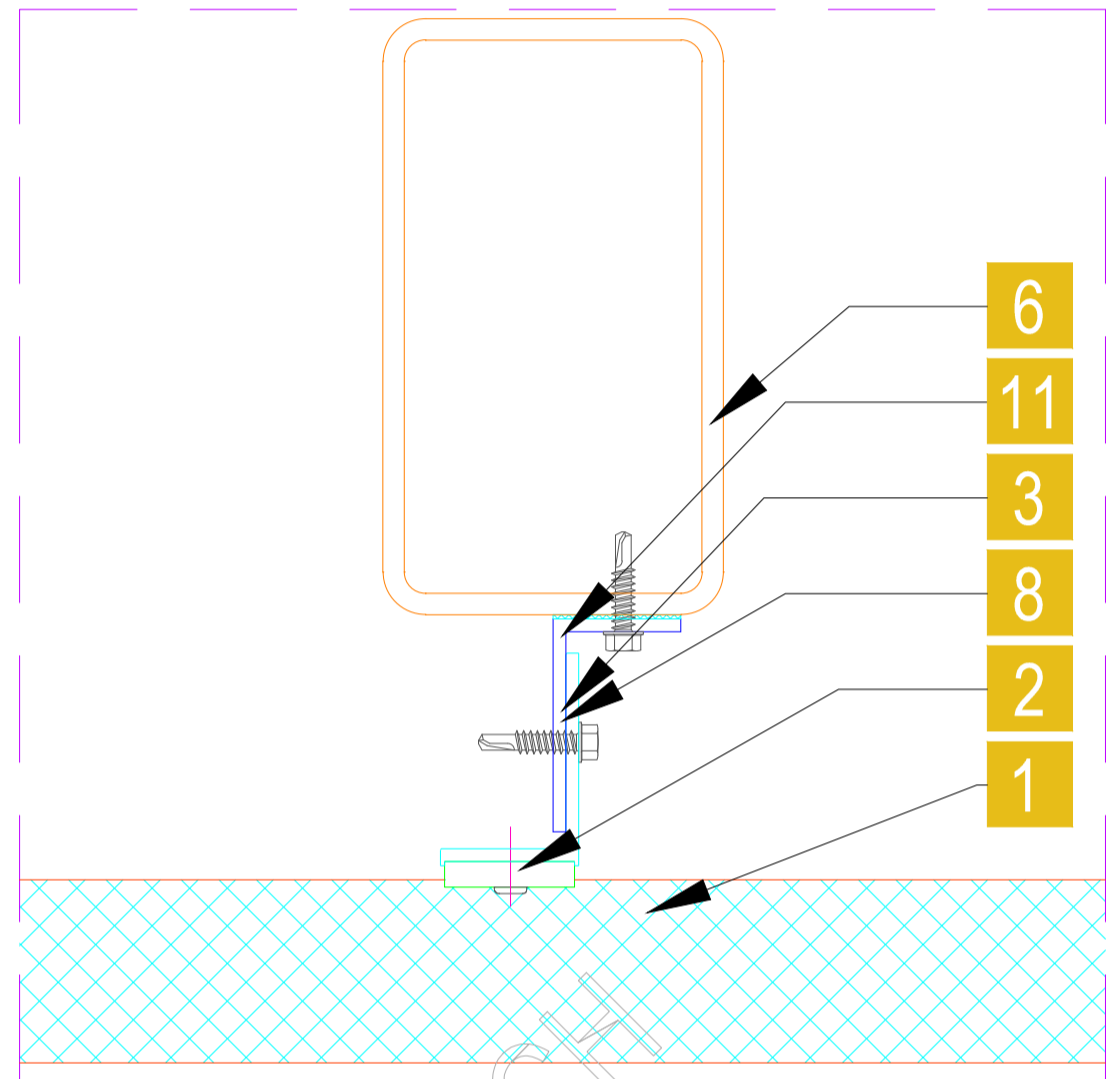

DETAIL 2 Option 2.
L shaped aluminum bracket.

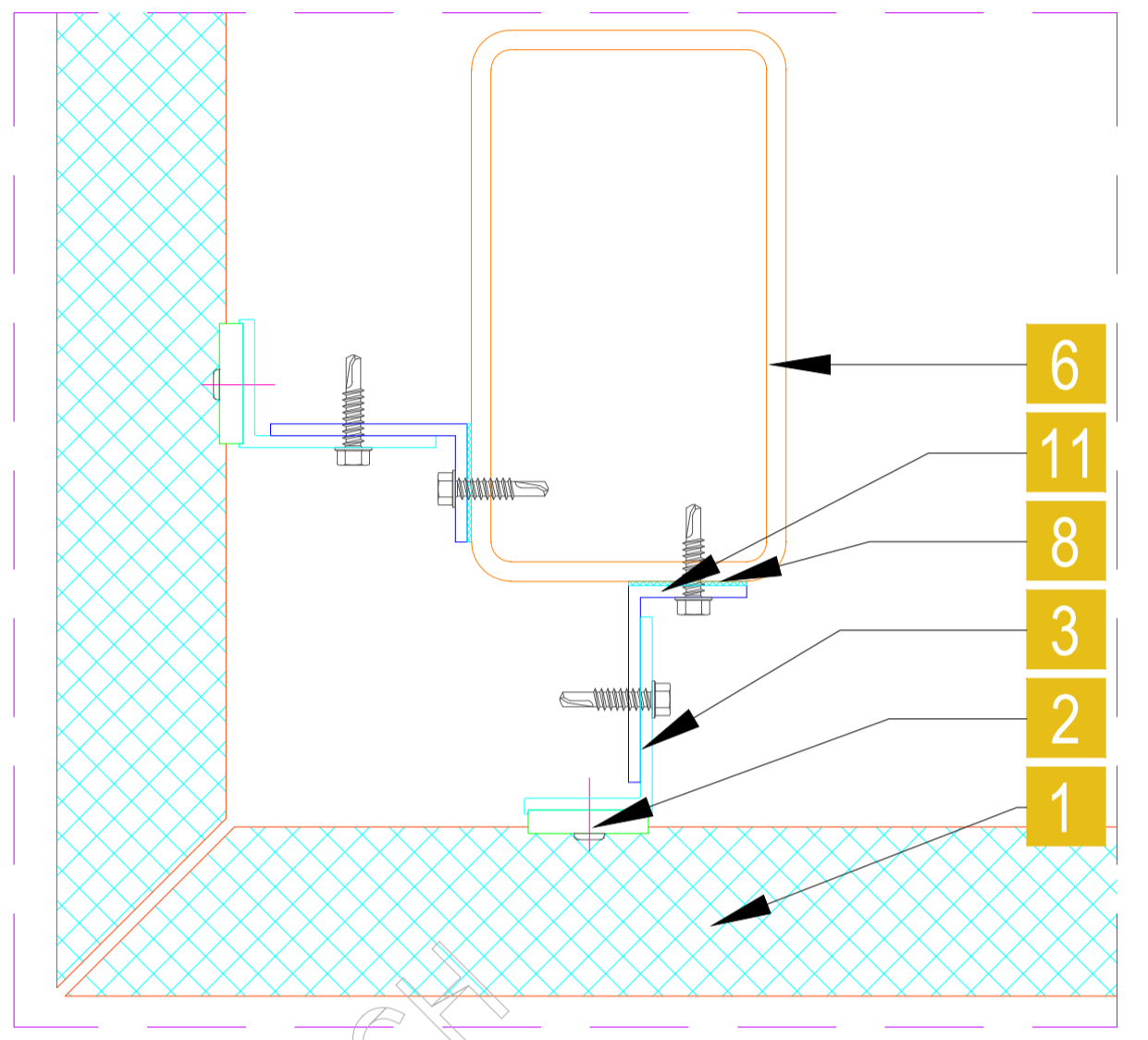

Corner

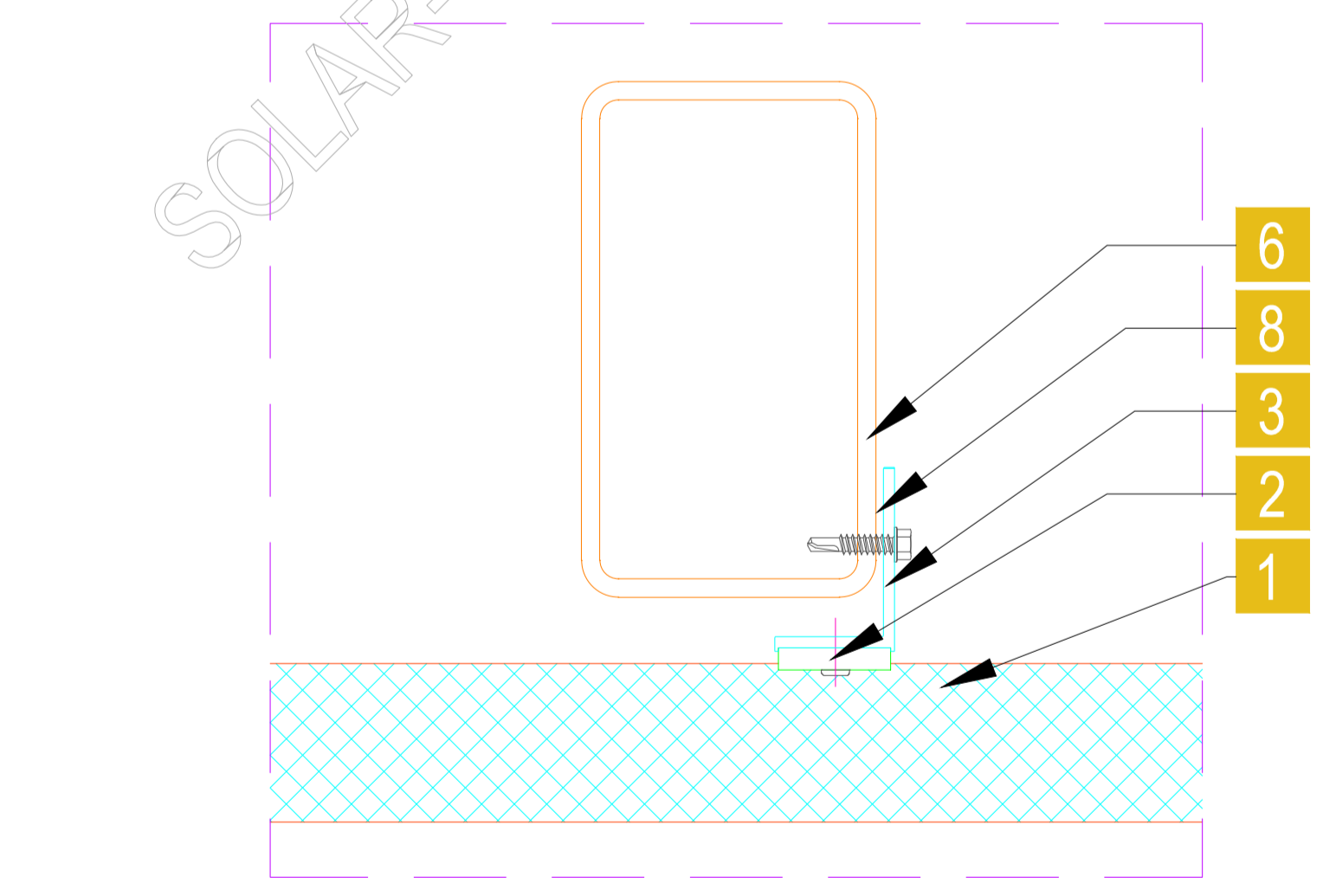

DETAIL 2 Option 3.
Side connection.

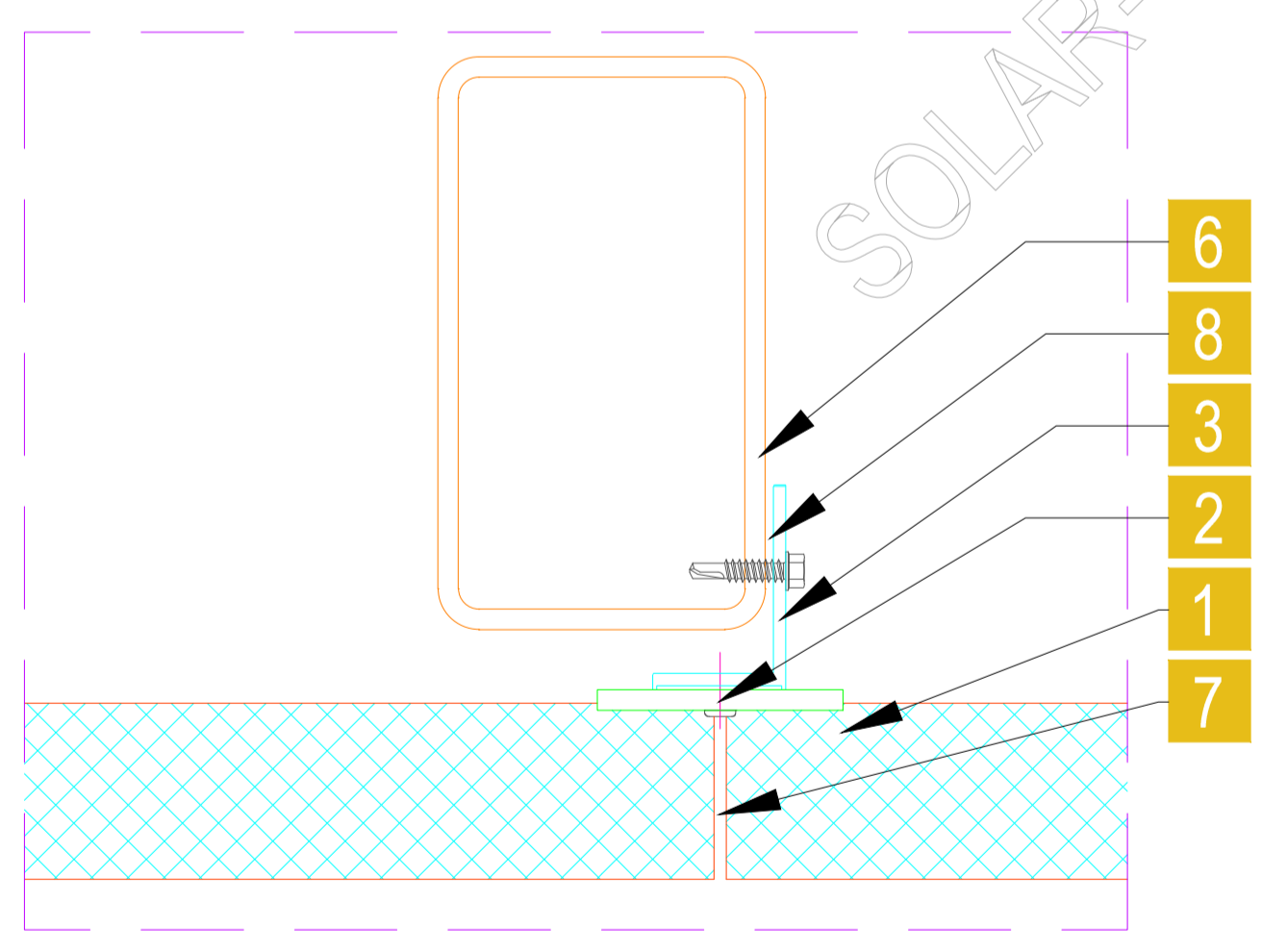

DETAIL 1.
Side connection with dilatation.

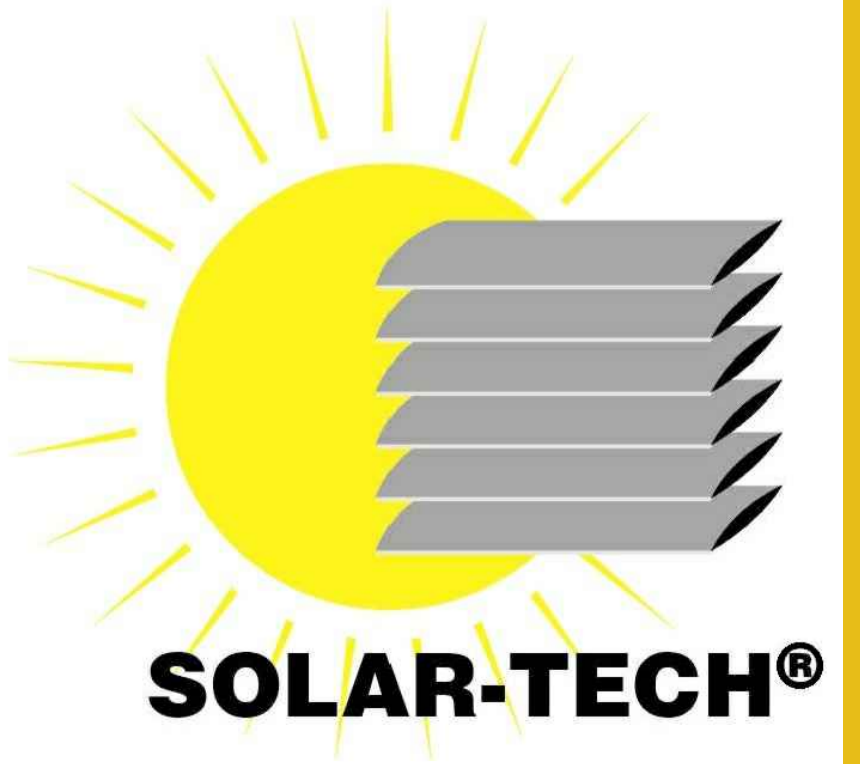

CAUTION!

Presented solutions are only a sample. In any doubts, please contact the Solar - Tech company. Pole and beams shape and sizes according to the technical calculation.